

DOCUMENT RESUME

ED 372 181

CE 064 969

AUTHOR Stevens, Nick; And Others  
 TITLE The Spray-Rite Kit. A Guide to Using Chemicals on the Farm.  
 INSTITUTION Victorian Coll. of Agriculture and Horticulture Ltd., Warragul (Australia).  
 SPONS AGENCY Adult, Community, and Further Education Board, Melbourne (Australia).  
 REPORT NO ISBN-1-86285-317-7  
 PUB DATE 93  
 NOTE 103p.  
 AVAILABLE FROM Adult Basic Education Resource and Information Service, National Languages and Literacy Institute of Australia, GPO Box 372F, Melbourne, Victoria 3001, Australia (\$26 Australian plus postage).  
 PUB TYPE Guides - Classroom Use - Instructional Materials (For Learner) (051)

EDRS PRICE MF01/PC05 Plus Postage.  
 DESCRIPTORS Adult Basic Education; \*Adult Farmer Education; Adult Literacy; Basic Skills; Developed Nations; Foreign Countries; \*Herbicides; \*Literacy Education; Measurement; \*Metric System; \*Numeracy; Rural Areas; \*Rural Education; Vocabulary Development  
 IDENTIFIERS Australia

ABSTRACT

This resource is designed to assist rural adult literacy students. It deals with chemicals on the farm and aims to help students understand the technical language, concepts, and operations associated with spraying safely and effectively. The kit proceeds step-by-step from purchase to disposal. Material is divided into two sections. Section 1 covers understanding chemical labels and meanings of many technical and special words that deal with chemicals. Section 2 looks at measuring length, measuring perimeter, measuring area, measuring liquids, and meanings of metric terms. The kit contains a wide range of reading and writing activities, discussion topics, self-help exercises, tests and quizzes, vocabulary exercises, and case studies. (YLB)

\*\*\*\*\*  
 \* Reproductions supplied by EDRS are the best that can be made \*  
 \* from the original document. \*  
 \*\*\*\*\*

# The Spray-Rite Kit

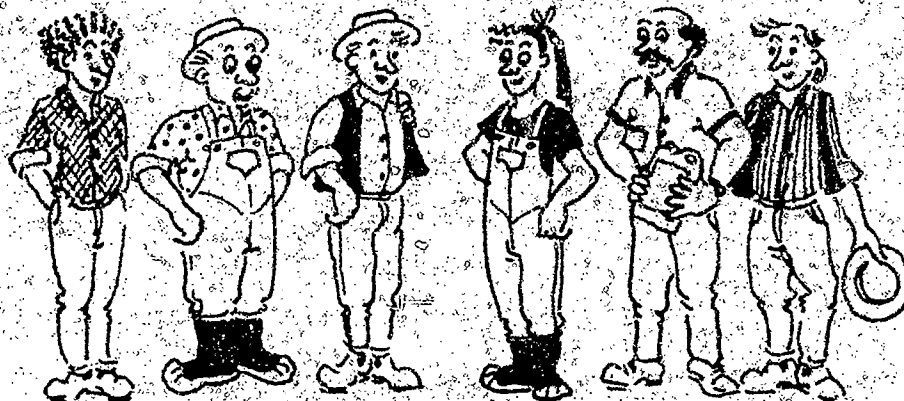

## A guide to using chemicals on the farm

U.S. DEPARTMENT OF EDUCATION  
Office of Educational Research and Improvement  
EDUCATIONAL RESOURCES INFORMATION  
CENTER (ERIC)

This document has been reproduced as received from the person or organization originating it  
 Minor changes have been made to improve reproduction quality

• Points of view or opinions stated in this document do not necessarily represent official OERI position or policy

"PERMISSION TO REPRODUCE THIS MATERIAL HAS BEEN GRANTED BY

TO THE EDUCATIONAL RESOURCES INFORMATION CENTER (ERIC)."



Produced by  
**Distance Learning Centre  
Victorian College of Agriculture and Horticulture Ltd**

For  
**The Adult, Community and Further Education Board, Victoria**

*Written by*  
**Nick Stevens  
Joanne Campbell  
Karen Manwaring  
John Fenwick**

*Illustrations*  
**Jennifer Gibney**



6064 569

# The Spray-Rite Kit

A guide to using chemicals on the farm

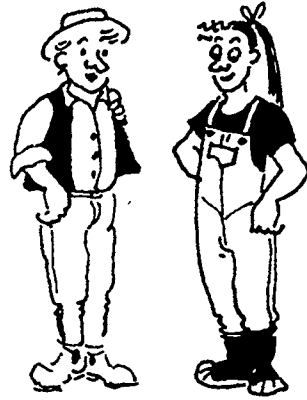

*Written by*  
**Nick Stevens**  
**Joanne Campbell**  
**Karen Manwaring**  
**John Fenwick**

*Illustrations*  
**Jennifer Gibney**



Produced by  
**Distance Learning Centre**  
**Victorian College of Agriculture and Horticulture Ltd**

For  
**The Adult, Community and Further Education Board, Victoria**



## **The Spray-Rite Kit**

First published 1991  
This reprint 1993

### **Writing and Design**

Nick Stevens, Literacy Project Officer, Distance Learning Centre, VCAH  
Joanne Campbell, Rural Education Officer, VCAH - McMillan  
Karen Marwaring, Adult Literacy Facilitator, Yallourn TAFE College  
John Fenwick, Distance Learning Centre, VCAH

Assisted by  
Neil Hauxwell and Ann Yeates

### **Project Manager**

John Fenwick, Distance Learning Centre, VCAH

Assisted by  
Bronwyn Penna (word processing)  
Jennifer Gibney (graphics)

Produced by the Distance Learning Centre  
Victorian College of Agriculture and Horticulture Ltd. (ACN 053 408 101)  
PO Box 938, Warragul, Victoria 3820  
for the Adult, Community and Further Education Board

Nick Stevens, **The Spray-Rite Kit**.

ISBN 1 86285 301 0  
ISBN 1 86285 309 6  
ISBN 1 86285 293 6  
ISBN 1 86285 317 7 (set)

© State of Victoria, 1993. Published by the Adult, Community and Further Education Division, Department of Education, Victoria. Copyright in this document is owned by the State of Victoria. The worksheets in this publication are able to be photocopied for classroom use only. Otherwise no parts may be reproduced by any process except with the express written permission of the Attorney-General for the State of Victoria or a person acting under her authority or in accordance with the provisions of the Copyright Act.

All enquiries in relation to this publication should be addressed to:

Adult, Community and Further Education Division  
Office of Training and Further Education  
Rialto South Tower  
525 Collins Street  
MELBOURNE 3000

This project was developed through a Grant provided by the Division of Further Education, now the Adult, Community and Further Education Division, Department of Education, Victoria.

### **Important Note**

#### **Disclaimer**

The rates and instructions given on the product label should always be checked before use, and followed exactly. The publisher accepts no responsibility for any loss or damage howsoever caused arising out of the use of any product referred to in this kit.

## Acknowledgements

Acknowledgement and thanks are due to numerous organisations and individuals for their assistance during development of **The Spray-Rite Kit** and for permission to use certain materials.

In particular, thanks to:

Kraft Foods Limited  
Vegemite label

Cadbury Schweppes Pty. Ltd.  
Schweppes Lime Juice Cordial Label.

Monsanto Australia Limited  
Roundup label and booklet  
Ramrod 650 label

Consolidated Fertilizer Sales Pty. Ltd.  
Shirweed 80 label

Ceiba-Geigy Aust. Ltd.  
Zero label

Hoechst Australia Ltd.  
Systhane

Peter Newgreen  
Rural Education Officer  
VCAH McMillan Campus

Greg Brinsmead  
Senior Lecturer  
VCAH McMillan Campus

Evelyn Schoenberger  
Regional Adult Literacy and Basic Education Officer  
Gippsland Regional Council of Adult Community and  
Further Education.

Thelma Smith  
Regional Adult Literacy and Basic Education Officer  
Gippsland Regional Council of Adult Community and  
Further Education

Adult Literacy Students  
Yallourn TAFE

---

# The Spray-Rite Kit

## 1. Understanding Labels

### (i) Understanding labels

This part of the kit looks at chemical labels. It looks at all the information you can get from reading the label.

### (ii) Glossary: Chemicals on the farm

This part of the kit explains the meanings of many technical and special words.

## 2. Measuring for Spraying

### (i) Measuring Length

This part of the kit looks at how to estimate and how to measure accurately.

### (ii) Measuring Perimeter

This part of the kit looks at how to work out the perimeters of different shapes.

### (iii) Measuring Area

This part of the kit looks at how to work out the areas of different shapes.

### (iv) Measuring Liquids

This part of the kit looks at common liquid measurements.

### (v) Glossary: Measuring with metrics

This part of the kit looks at metric terms and what they mean.

# The Spray-Rite Kit

## 1. Understanding Labels



# The Spray-Rite Kit

## (i) Understanding Labels

Welcome to the Spray-Rite Kit.....	1
Tutor notes .....	2
Understanding labels .....	3
Chemical labels.....	5
The schedule.....	9
Trade name.....	11
Manufacturer and manufacturer's address .....	13
Guide to further instructions, warranty and liability.....	15
The label on the back.....	15
Safety directions.....	17
First aid.....	19
Protection of livestock, wildlife and environment.....	20
Storage, disposal and protection of others .....	21
Read the label before.....	22
Limit of warranty and liability.....	23
Pesticide type .....	24
Active constituent and concentration .....	25
Registered target.....	28
Amount of contents .....	30
Quiz activities .....	31
Other ways to control pests.....	34

## (ii) Glossary: Chemicals on the farm.....35



## Welcome to the Spray-Rite Kit

Do you use sprays around your farm?

YES

NO

Have you ever been confused by labels or spray instructions?

YES

NO

If you answered YES to these questions you need the Spray-Rite Kit.

The Spray-Rite Kit is a step-by-step look at using chemicals on the farm.

The Spray-Rite Kit looks at practical, real-life problems.

The Spray-Rite Kit will help you to understand labels.

The Spray-Rite Kit will help you to understand metrics.

Sprays contain poisons. You want to protect yourself, your family, your neighbours, your land, stock and crops.

Sprays are expensive. You don't want to waste them by using too much or too little.



The Spray-Rite Kit will help you spray safely and effectively.

## Welcome to the Spray-Rite Kit

# THE SPRAY-RITE KIT

## TUTOR NOTES

The Spray-Rite Kit is designed for rural adult literacy students.

The Kit deals with chemical use on the farm using the herbicide **Roundup** as a case study.

The Kit aims to help students understand the technical language, concepts and operations, associated with spraying safely and effectively.

The Kit proceeds step-by-step from purchase to disposal and includes material on:

- Understanding labels
- Using booklets
- Metrics
- Measuring, mixing and application
- Safety and First Aid
- Storage
- Clean-up and disposal



The Kit contains a wide range of reading and writing activities, discussion topics, self-help exercises, tests and quizzes, vocabulary exercises and case studies.

The Kit deals with practical, real-life rural situations, and has been specially developed for use in the rural community.

Use the Kit **as** a kit, choosing and adapting those items that will be most relevant and useful to your student.

Like most kits, Spray-Rite is really only a springboard into a whole world of adult literacy activities.

**Welcome to the Spray-Rite Kit**

## UNDERSTANDING LABELS

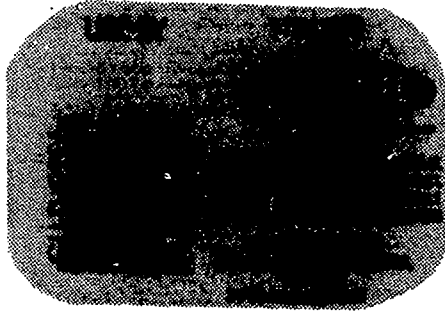

Here are some common Australian labels.

They all look different, but they are similar in many ways.

Each label gives us information about the product.

- The labels tell us the product's name.
- The labels tell us who made the product.
- The labels say how much of the product is in the container.
- The labels tell us what is in the product.

Look at the labels and answer the following questions:

1. How many grams of Vegemite in the jar?

.....

2. What is the name of the company that makes White Crow Tomato Sauce?

.....

3. Does White Crow Tomato Sauce contain sugar?

.....

4. What is the name of the company that makes Vegemite?

.....

5. How many millilitres (ml) of cordial in the Lime Juice Cordial bottle?

.....

**ACTIVITY**

Labels are all around us. Every room in your house probably has something with a label on it.

Don't just take our word for it. Go and have a look.

Collect a number of different jars, packets or containers. What information is written on these labels?



## UNDERSTANDING LABELS

Now let's look at chemical labels.

### WARNING

KEEP OUT OF REACH OF CHILDREN  
READ SAFETY DIRECTIONS BEFORE OPENING



**Roundup**  
Herbicide by M

ACTIVE CONSTITUENT:  
360 g/L GLYPHOSATE  
(present as the isopropylamine salt)

Water soluble herbicide for non-selective control of many annual and perennial weeds in certain situations.

**20 LITRES NET**

READ THE ATTACHED BOOKLET BEFORE USING THIS PRODUCT.  
Read 'Limit of Warranty and Liability' before buying or using.

Monsanto Australia Limited (Incorporated in Victoria)  
600 St. Kilda Road, Melbourne 3004.

**Chemical labels are similar to other kinds of labels.**

The label tells us the product's name.  
The label tells us who made the product.  
The label tells us what is in the container.  
The label tells us what the chemical is used for.

**BEST COPY AVAILABLE**

If you are going to use a chemical, you will need to understand the information on the label.

The time spent reading and understanding the label may mean the difference between

**SUCCESS**

**OR**

**FAILURE**

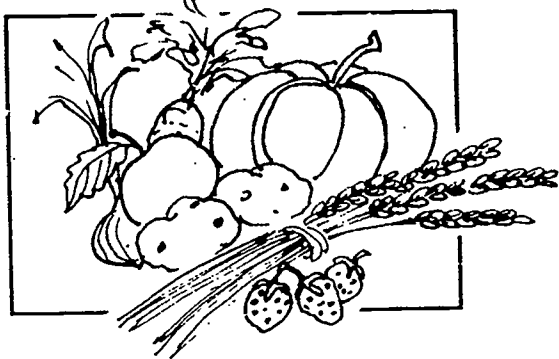

**OR**

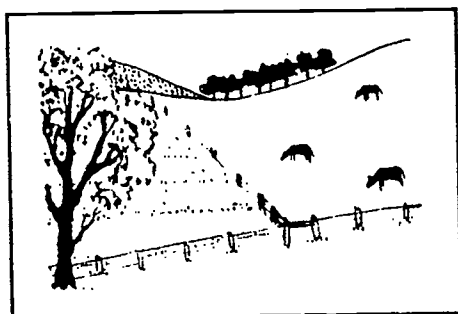

**OR**

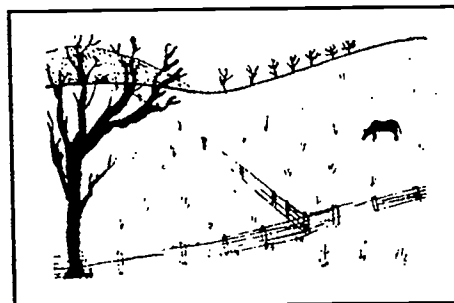

**OR**



**Remember:**

Sprays are expensive. You don't want to waste them by using too much or too little.

Sprays contain poisons. You want to protect yourself, your family, your neighbours, your land, stock and crops.

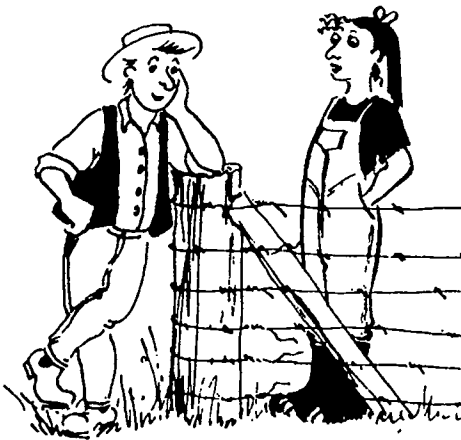
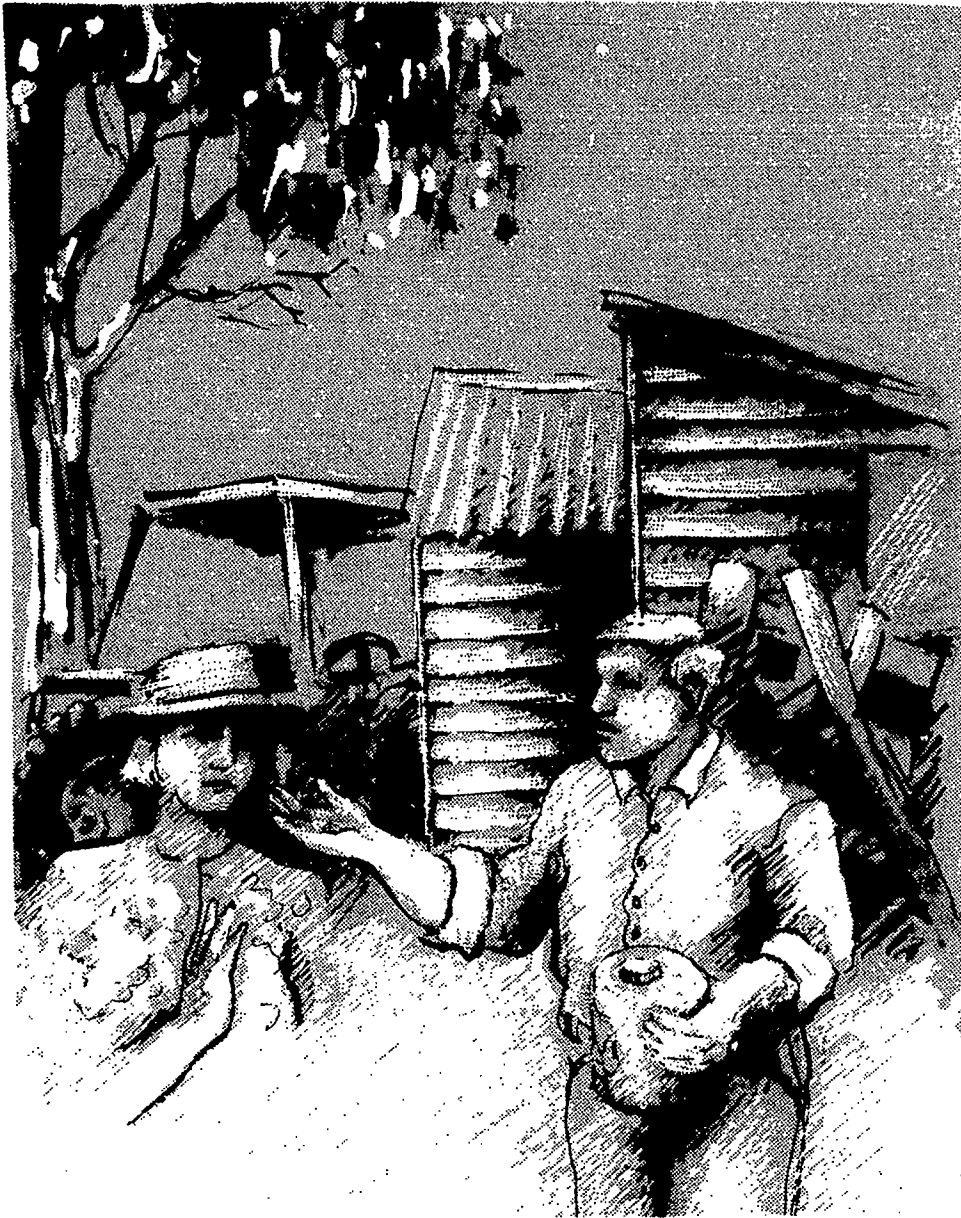

#### **DISCUSSION TOPIC**

Carol said to Ron, "We always plan everything else that we do. Why don't we plan our spraying program too? After all, we don't go out and use any old fertilizer or any sort of stockfeed."

What are the advantages of reading the label and planning your spraying program?

Are there any disadvantages?



## UNDERSTANDING LABELS

Chemical labels give you the information you will need to make decisions. The label gives you the information you will need to spray safely and effectively.

Let's look at a typical chemical label.

1. The Schedule

**WARNING**

KEEP OUT OF REACH OF CHILDREN  
READ SAFETY DIRECTIONS BEFORE OPENING

2. Trade Name

**Roundup**

Herbicide by M

3. Manufacturer

6. Pesticide Type

8. Concentration

ACTIVE CONSTITUENT:  
360 g/L GLYPHOSATE  
(present as the isopropylamine salt)

7. Active Constituent

Water soluble herbicide for non-selective control of many annual and perennial weeds in certain situations.

READ THE ATTACHED BOOKLET BEFORE USING THIS PRODUCT.  
Read 'Limit of Warranty and Liability' before buying or using.

20 LITRES NET

9. Registered Target

10. Amount of Contents

5. Guide to Further Instructions  
Warranty and Liability

Monsanto Australia Limited (Incorporated in Victoria)  
600 St. Kilda Road, Melbourne 3004.

4. Manufacturer's Address



A chemical label has ten main parts. Let's look at the ten main parts of a typical chemical label.

### 1. The Schedule

Warnings help us to avoid dangerous situations.

Signs warning us about possible dangers are all around us.

What could happen if we ignored the following warning signs?



**CAUTION** S2  
TO BE USED STRICTLY AS DIRECTED  
KEEP OUT OF REACH OF CHILDREN  
*Fluoride Dietary Supplement*  
Each tablet contains.  
2.2 mg SODIUM FLUORIDE  
100 TABLETS 2.2mg

All chemical labels carry warnings. These warnings are called Schedules.

This is a Schedule from a chemical label.

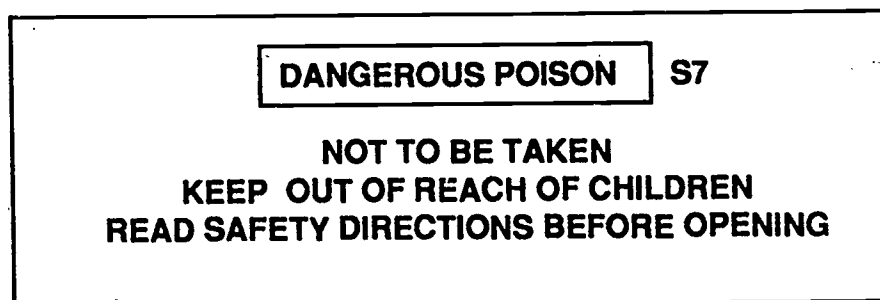

The Schedule tells you the level of danger of that chemical.

It tells you how toxic or poisonous the chemical is.

There are three different levels of danger so there are three different Schedules.

The three different Schedules are:

Schedule 5

**WARNING**

**KEEP OUT OF REACH OF CHILDREN  
READ SAFETY DIRECTIONS BEFORE OPENING**

Schedule 6

**POISON**

**NOT TO BE TAKEN  
KEEP OUT OF REACH OF CHILDREN**

Schedule 7

**DANGEROUS POISON** S7

**NOT TO BE TAKEN  
KEEP OUT OF REACH OF CHILDREN**

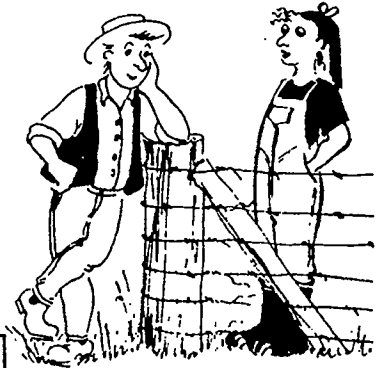

**DISCUSSION TOPIC**

There is one sentence that is used in all three Schedules. What is that sentence? Why is it so important?

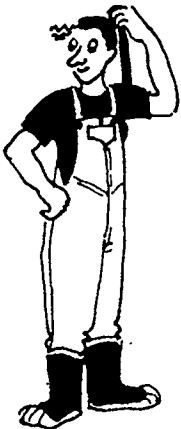

**QUESTIONS**

Find the Schedule on the Roundup label.

Which level of danger does it belong to?

.....  
What does the Schedule tell us about storage?

.....  
What should we do before opening the container?

.....  
Look at page 9 of the Ron and Carol story. How safe was Ron's storage of his chemicals?

.....

## ACTIVITY

How safely are your chemicals stored?  
Draw a plan of your shed area. Mark where you have your chemicals stored.

Indicate any possible hazards.

Indicate any special safety precautions you have set up.

On a scale of 1 to 10 give your shed a chemical safety rating.

How would you rate your laundry?

How would you rate your kitchen?



## 2. Trade Name

Every product has a trade name.

Cars have trade names. (Nissan Patrol, Honda Civic...)  
Biscuits have trade names (Butternut Snap, Sao...)  
And chemicals have trade names (Roundup, Zero...)

A trade name is simply the name used when the product is traded.

Some chemicals have very strange trade names. For example:

Gesaprim  
Vorax AA  
Amoxone

Some chemicals have trade names that are a bit more catchy. For example:

Avenge  
Stomp  
Weedoben  
Weedazol Total  
Stampede

Lane Railway Special  
Ramrod  
Erase  
Zero

Roundup is a catchy sort of trade name. What does the name Roundup suggest to you?

### ACTIVITY

A lot of trade names that you see are spelt the wrong way. For example:

Weet-Bix

Find three labels with trade names that are spelt the wrong way.

Have the manufacturers made a mistake or is there a reason for spelling the words the wrong way?



### SELF-HELP EXERCISE

A lot of trade names are made up of two words joined together. For example:

Round + up = Roundup.

A lot of words are made up of two words joined together.

Look at any page from a newspaper or magazine.

Underline any words that are made up of two words joined together.

Discuss your list of words with your tutor. Discuss spelling hints or rules for joining words together.



### 3. Manufacturer

The manufacturer is the company that makes or manufactures the product.

Monsanto manufactures Roundup. Monsanto is the manufacturer.

#### ACTIVITY

Look at the labels on page 3.

Who manufactures the following products?

1. Vegemite is manufactured by

.....

2. Schweppes Lime Juice Cordial is manufactured by

.....



### 4. Manufacturer's Address

Labels should always show the name and address of the company that makes the product.

If you know the manufacturer's address you can contact them if you have any problems.

If you know the manufacturer's address you can contact them if you have any questions.

If you know the manufacturer's address you can contact them if you want to praise their product.

#### ACTIVITY

Write down one problem, complaint or compliment for any product that you have used.

Write a letter to the company that manufactured that product outlining your problem, complaint, question or praise.



Product Manager  
Seed Tree Co-op  
18 Fenwick Street  
Forestville 2087

Susan Hall  
4 Park Road  
Leongatha 3953

30 April, 1991

Dear Madam,

Just a short note to tell you how pleased we are with the very high quality of your plastic tree guards.

We have used them for the past two years with very good results. The flexible mesh guards are particularly good - quick to use, very strong and easily seen.

Our seedlings have shown good survival and growth rates.

Looking forward to dealing with you again in the future.

Yours faithfully,

S. Hall

The Manager  
Dodgy Furniture Co. Pty. Ltd.  
10 Crooked Lane  
Warragul 3820

Mr. John Parker  
6 Suite Court  
Drouin 3818

30 April, 1991

Dear Sir,

I bought a brand new kitchen table from your store on 26 April, 1991. It was a "Royal Breakfast" model and cost me \$395.

Using it for the first time last Sunday, I noticed one of the legs seemed a bit wobbly. While I was looking at this wobbly leg, two of the drawers dropped out. Then the leg fell off. Then the top cracked open revealing the borer holes. Now I notice that the "Genuine marble cutting board" is in fact a plastic imitation!

I would be grateful if you could arrange for this "table" to be taken away as soon as possible. I will certainly require a full refund.

I trust that you will give this matter your urgent attention.

Yours faithfully,

J. Parker

Make sure you copy the manufacturer's address from the label onto the top left hand corner of your letter. Include your own address on the top right hand corner of your letter.

If you have any problems or questions about using a chemical product you may need to contact the manufacturer.

However, you may be able to work out the answer for yourself by reading the *Guide To Further Instructions, Warranty and Liability*.

## 5. Guide to Further Instructions, Warranty and Liability

The label on the front of the Roundup container says that there is more information on the back of the Roundup container.

The label on the back of the Roundup container says that there is more information in the little label booklet.

**So much information! So many details!**

Like Ron, you might be fed up with all this information. You might just want to get out there and spray any old way.

### BUT REMEMBER

Sprays contain poisons. You want to protect yourself, your family, your neighbours, your land, stock and crops.

Sprays are expensive. You don't want to waste them by using too much or too little.

Let's look at the label on the back of the container.

# Roundup

Herbicide by Monsanto

## DIRECTIONS FOR USE

FOR SPECIFIC RATES OF APPLICATION AND COMPLETE DIRECTIONS FOR USE READ ATTACHED LABEL BOOKLET.

NOTE: Use of this product in any manner not consistent with this label may result in injury to persons, animals or crops, or other unintended consequences.

NOT TO BE USED FOR ANY PURPOSE, OR IN ANY MANNER, CONTRARY TO THIS LABEL UNLESS AUTHORISED UNDER APPROPRIATE LEGISLATION.

## SAFETY DIRECTIONS

- Avoid contact with eyes and skin
- When preparing product for use, wear elbow-length PVC gloves and face shield or goggles.
- After use, and before eating, drinking or smoking, wash hands, arms and face thoroughly with soap and water
- After each day's use wash contaminated clothing, gloves and face shield or goggles
- When using controlled droplet applicator, wear protective waterproof clothing and impervious footwear

## FIRST AID

- If poisoning occurs contact a doctor or Poisons Information Centre
- If swallowed, do NOT induce vomiting. Give a glass of water
- If skin contact occurs, remove contaminated clothing and wash skin thoroughly
- If in eyes, hold eyes open, flood with water for at least 15 minutes and see a doctor

## PROTECTION OF CROP, NATIVE AND OTHER NON-TARGET PLANTS

- Avoid contact with foliage, green stems or fruit of crops, desirable plants and trees, since severe injury or destruction may result

## PROTECTION OF WILDLIFE, FISH, CRUSTACEA AND ENVIRONMENT

- Do not contaminate dams, rivers or streams with the product or used container

© Registered trademark of Monsanto Company USA. Used under licence by Monsanto Australia Limited. © Copyright Monsanto Australia Ltd. April 1989

## STORAGE, DISPOSAL AND PROTECTION OF OTHERS

- Store in the closed original container. Avoid prolonged storage in direct sunlight. Do not contaminate seed, feed or foodstuff
- Spray solutions of this product should be mixed, stored and applied only in stainless steel, aluminum, brass, copper, fibreglass, plastic or plastic-lined containers
- Do not mix, store or apply this product or spray solutions of this product in galvanized steel or unlined steel (except stainless steel) containers or spray tanks. This product, or spray solutions of this product react with such containers and tanks to produce hydrogen gas which may form a highly combustible gas mixture that can flash or explode if ignited by open flame, spark, welder's torch, lighted cigarette or other ignition source.
- Spray tanks, pumps, lines and nozzles should be thoroughly rinsed with clean water following application to prevent corrosion
- Do not re-use container for any purpose. Destroy when empty

## LIMIT OF WARRANTY AND LIABILITY

Monsanto Australia Limited ("Monsanto") warrants that this material conforms to the chemical description on the label and further warrants that it is of merchantable quality. Subject thereto Monsanto makes no representation or warranty of any kind as to fitness for any particular purpose or any other matter with respect to these goods whether used alone or in conjunction with other substances and all conditions and warranties, expressed or implied by law, are hereby expressly excluded to the maximum extent permitted by law. To the extent permitted by law Monsanto's liability for any alleged damage or defective goods or any other cause whatsoever, including alleged negligence, shall be limited (at Monsanto's election) to the replacement of the goods or the repair of the goods or the cost of repair of or replacement of the goods in respect of which the claim is made.

Not for re-packaging or re-formulation. No licence, under any non-Australian patent is granted or implied by purchase of this container

SPECIALIST ADVICE IN EMERGENCY ONLY: PHONE 008 033111  
All hours, Australia-wide

# Monsanto



9 513771 001079

IMP 201 939C 72

BEST COPY AVAILABLE

15  
23

# Roundup

Herbicide by **Monsanto**

## DIRECTIONS FOR USE

FOR SPECIFIC RATES OF APPLICATION AND COMPLETE DIRECTIONS FOR USE READ ATTACHED LABEL BOOKLET.



**NOTE:** Use of this product in any manner not consistent with this label may result in injury to persons, animals or crops, or other unintended consequences.

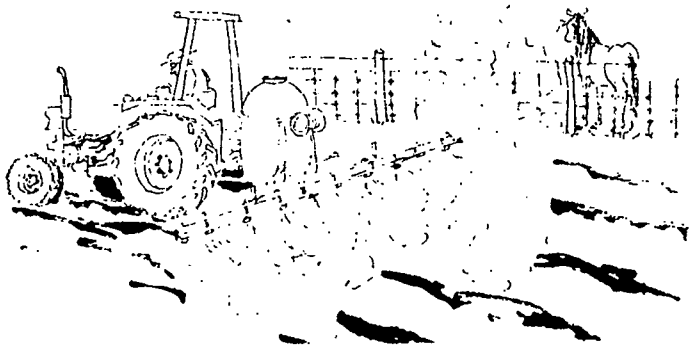

**NOT TO BE USED FOR ANY PURPOSE, OR IN ANY MANNER, CONTRARY TO THIS LABEL UNLESS AUTHORISED UNDER APPROPRIATE LEGISLATION.**



Tells you that many more important details are in the little ROUNDUP booklet.

Roundup is non-selective. If you are not careful it could damage more than just the weeds. It could also damage your shrubs, fruits and vegetables. It could harm you. It could harm your animals.

This is a reminder to follow all the label instructions. When it comes to using poisons, the time spent reading the label is the most important time.



## Safety Directions

Sprays contain poisons. You want to protect yourself, your family, your neighbours, your land, stock and crops.

Here are some of the most important safety directions.

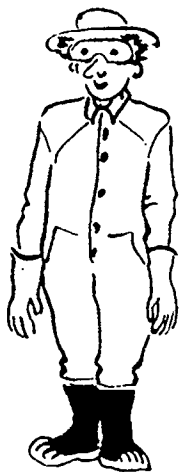

### SAFETY DIRECTIONS

- Avoid contact with eyes and skin.
- When preparing product for use, wear elbow-length PVC gloves and face shield or goggles.
- After use, and before eating, drinking or smoking, wash hands, arms and face thoroughly with soap and water.
- After each day's use wash contaminated clothing, gloves and face shield or goggles.
- When using controlled droplet applicator, wear protective waterproof clothing and impervious footwear.

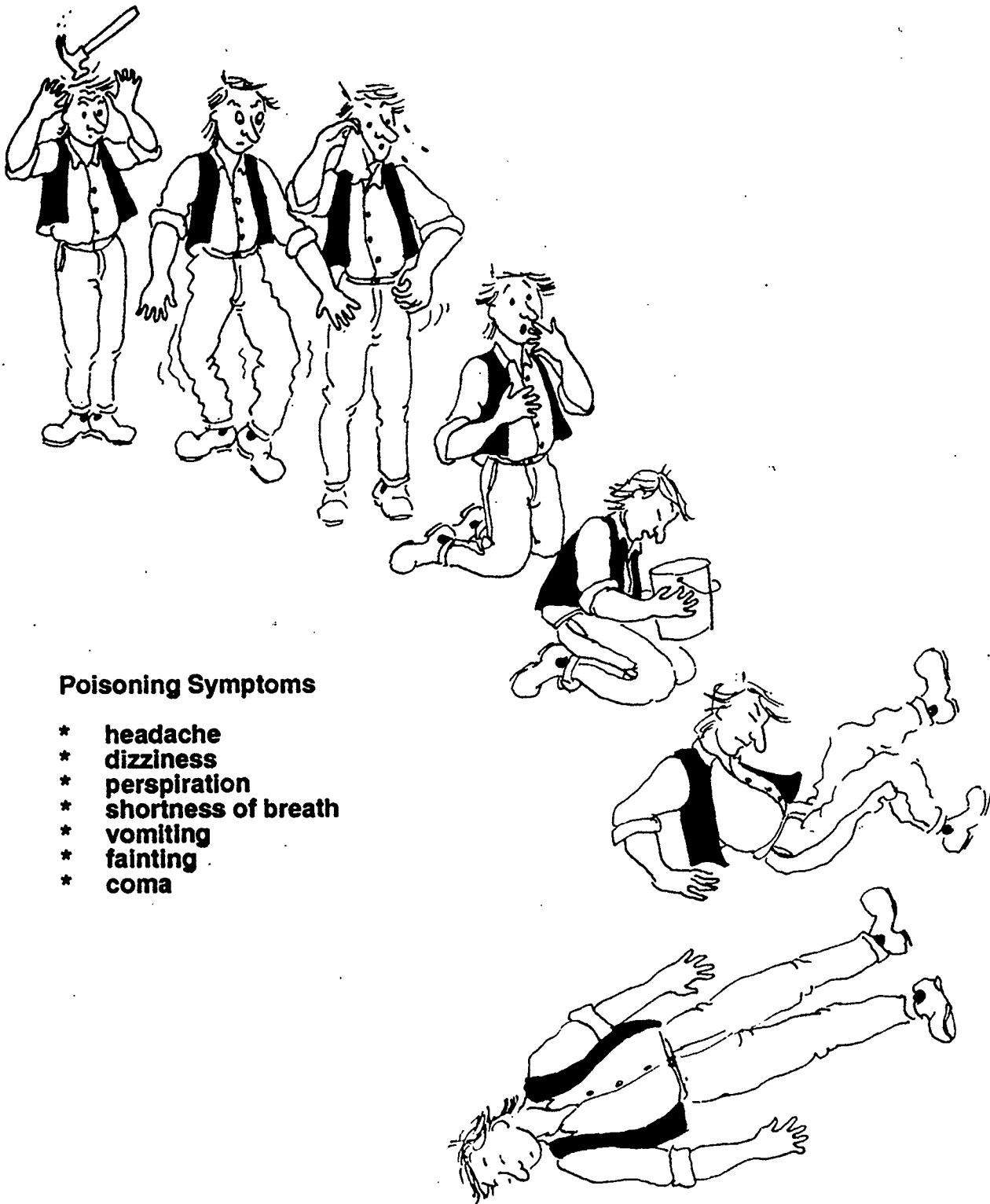

**Poisoning Symptoms**

- \* **headache**
- \* **dizziness**
- \* **perspiration**
- \* **shortness of breath**
- \* **vomiting**
- \* **fainting**
- \* **coma**

## First Aid

Here are some basic first aid instructions.



### FIRST AID

- If poisoning occurs, contact a doctor or Poisons Information Centre.
- If swallowed, do NOT induce vomiting. Give a glass of water.
- If skin contact occurs, remove contaminated clothing and wash skin thoroughly.
- If in eyes, hold eyes open, flood with water for at least 15 minutes and see a doctor.

POISONS INFORMATION NUMBER

008 133890



Can you remember these first aid instructions? Will you remember them after ...

one hour?  
one day?  
one week?

Put a note on your calendar to test yourself in one week.

Can you remember the five safety directions on page ( )?

## Protection of Livestock, Wildlife and Environment

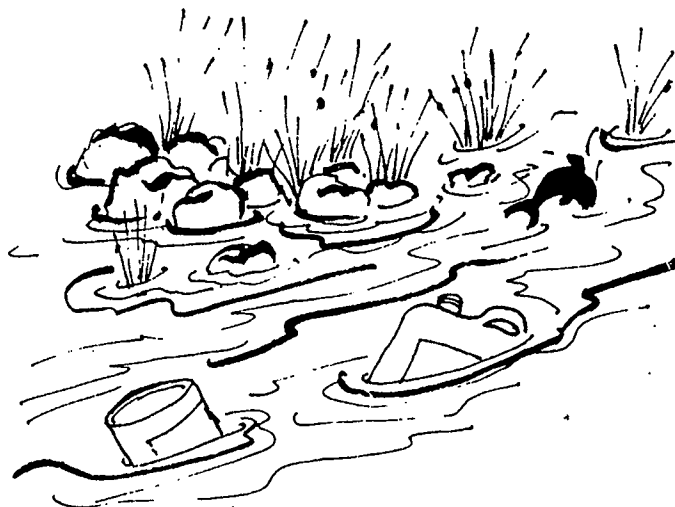

### PROTECTION OF CROP, NATIVE AND OTHER NON-TARGET PLANTS

- Avoid contact with foliage, green stems or fruit of crops, desirable plants and trees, since severe injury or destruction may result

### PROTECTION OF WILDLIFE, FISH, CRUSTACEA AND ENVIRONMENT

- Do not contaminate dams, rivers or streams with the product or used container.

## Storage, disposal and protection of others

Here are some important facts about storage and disposal.

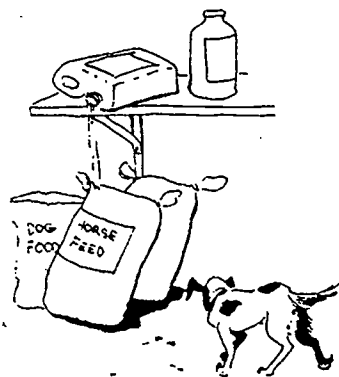

### STORAGE, DISPOSAL AND PROTECTION OF OTHERS

- Store in the closed original container. Avoid prolonged storage in direct sunlight. Do not contaminate seed, feed or foodstuff.
- Spray solutions of this product should be mixed, stored and applied only in stainless steel, aluminium, brass, copper, fibreglass, plastic or plastic lined containers.
- Do not mix, store or apply this product or spray solutions of this product in galvanized steel or unlined steel (except stainless steel) containers or spray tanks. This product, or spray solutions of this product react with such containers and tanks to produce hydrogen gas which may form a highly combustible gas mixture that can flash or explode if ignited by open flame, spark, welder's torch, lighted cigarette or other ignition source.
- Spray tanks, pumps, lines and nozzles should be thoroughly rinsed with clean water following application to prevent corrosion.
- Do not re-use container for any purpose. Destroy when empty.

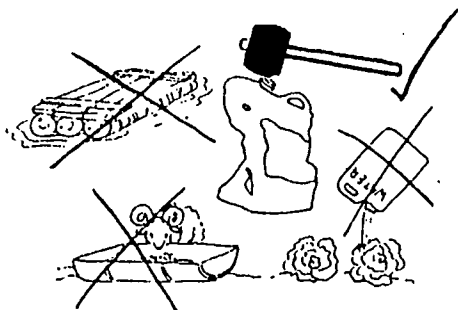
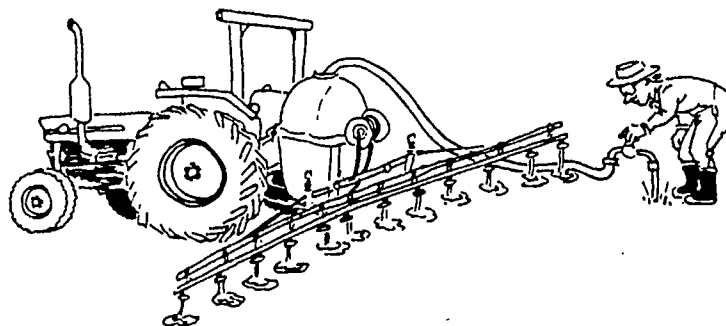

**Read the label before:**



**Purchasing**



**Opening**

**Mixing and applying**



**Storing**



## **Limit of Warranty and Liability**

A warranty is a bit like a promise.

In this case it is a legal promise. The warranty tells you that the poison inside the container is the poison described on the label.

The warranty also promises that the product is fit for use.

### **Liability is legal responsibility.**

How legally responsible is a company if a product doesn't work properly? Monsanto is saying here that they are legally responsible 'to the extent permitted by law'.

Questions about liability are complex and technical. So are the answers.

Check with the company or a solicitor if you require detailed information on liability.

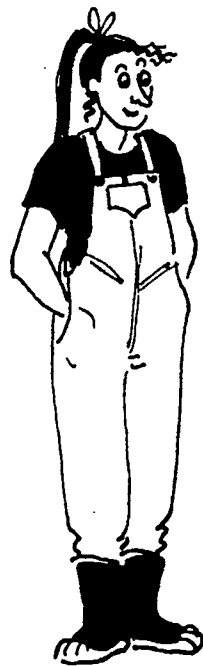

**6. Pesticide Type**

A pesticide is any chemical that controls pests.

Look at the word **pesticide**.

It is made up of two words. **pest + cide**.

**cide** is a French word. It means "to cut or kill".

So a **pest-i-cide** is something that attacks or kills pests.

An **insect-i-cide** is something that kills insects.

A **herb-i-cide** is something that kills plants.

**QUESTIONS**

A fungicide is something that kills

.....

A miticide is something that kills

.....

**Now try these tricky ones.**

Infanticide means to kill an

.....

Homicide means to kill

.....

Regicide means to kill

.....

Suicide means to kill

.....

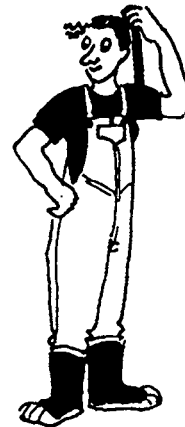

Look at the Roundup label. What type of pesticide is Roundup?

.....

What kinds of pests does it control?

.....



## 7. Active Constituent

Pesticides are made up of many different chemicals.

The most important chemical in any pesticide is called the active constituent.

The active constituent is the chemical which works to control the pest.

It's the active bit.

Without the active constituent there would be no **cide** in your **pest-I-cide**.

### QUESTION

Look at the Roundup label.

The active constituent in Roundup is

.....

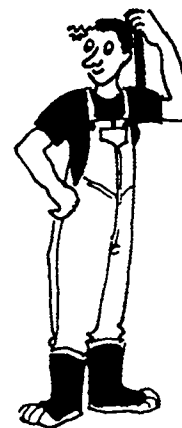

## 8. Concentration

Pesticides are made up of many different chemicals.

The concentration figure tells you how much of the active constituent is mixed in with the other chemicals.

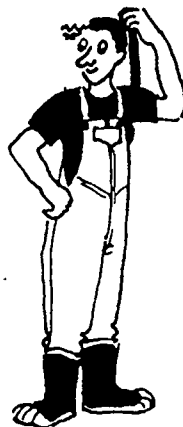

### QUESTION

Look at the Roundup label.

What is the active constituent?

.....

There are ..... grams of Glyphosphate in every litre of Roundup.

**WARNING**  
KEEP OUT OF REACH OF CHILDREN  
READ SAFETY DIRECTIONS BEFORE OPENING

# zero<sup>®</sup>

## WEEDSPRAY

ACTIVE CONSTITUENT:  
100g/L GLYPHOSATE PRESENT AS THE ISOPROPYLAMINE SALT



Oxalis  
Species



Kikuyu



Paspalum



Lantana



Bamboo



Onion  
Weed

Kills weeds and grasses as indicated in  
Directions for use, Roots and All

1 LITRE NET

4529

### QUESTION

Look at the Zero label.

The active constituent in Zero is

.....

There are ..... grams of .....  
in every ..... of Zero.

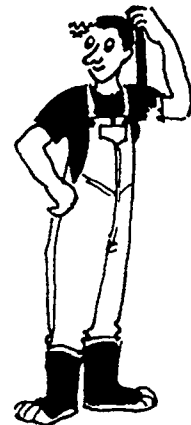

**WARNING**

KEEP OUT OF REACH OF CHILDREN  
READ SAFETY DIRECTIONS BEFORE OPENING

# Sythane<sup>®</sup>

## WP FUNGICIDE

Active Constituent: 400 g/kg 2-(4-CHLOROPHENYL)-2-(1H-1,2,4-TRIAZOL-1-YLMETHYL)HEXANENTRILE

For the control of black spot on apples and pears  
and powdery mildew on apples



Hoechst Australia Limited (Inc. in A.C.T.) Agrvet Division, Horticultural Section  
606 St. Kilda Road, Melbourne 3004. Phone: (03) 522 1212

\*Sythane is a registered trade mark of Rohm & Haas Company Philadelphia U.S.A.

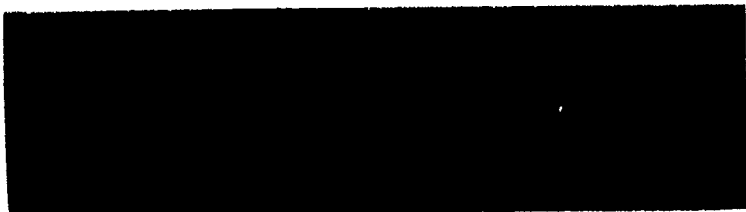

**QUESTION**

Look at the Sythane label.

The active constituent in Sythane is

.....

There are ..... grams of .....  
in every ..... of Sythane.

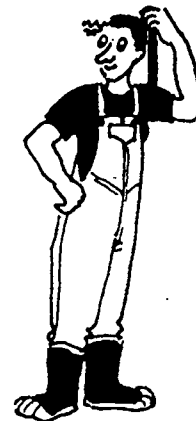

## 9. Registered target

Before you buy a chemical product you want to make sure it is the right product for the pest you want to control.

First of all you must know what the pest is.

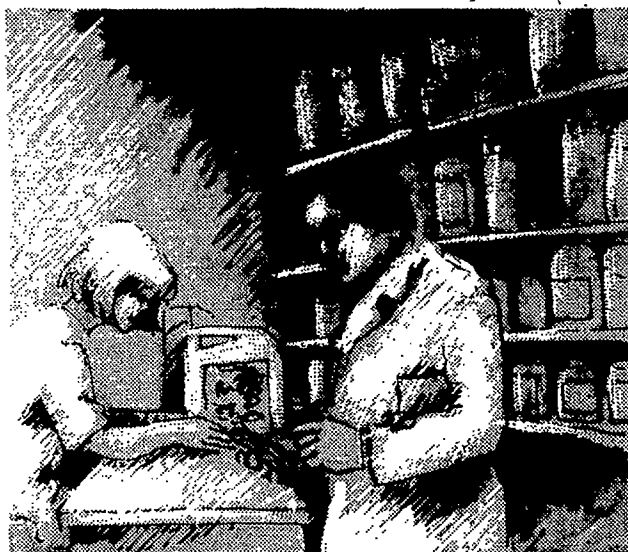
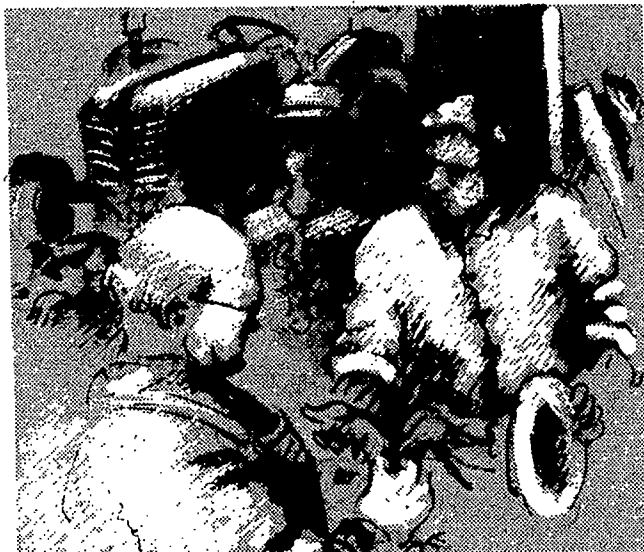

Ron and Carol knew they had a weed problem, but they didn't know exactly what the weed was.

They asked their neighbour Bill. Carol took some of the weed to the Stock Agent.

Bill said the weed was Bent Grass. The Stock Agent agreed.

**Bent Grass was the target.**

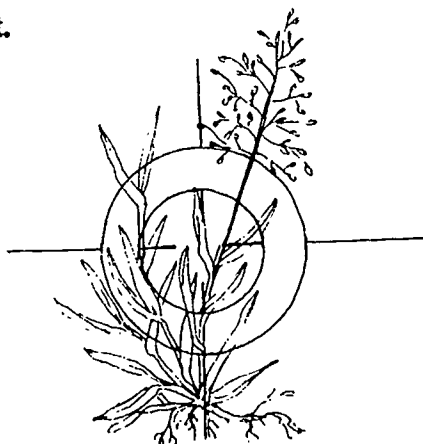

Ron wanted to blast the weeds with any old poison.

He didn't stop to think if the poisons would work on Bent Grass.

He didn't stop to think if they needed special safety precautions.

He didn't stop to think how much to use.

He didn't stop to think if the chemicals would also kill other grasses or useful bugs.

He didn't stop to think if the chemicals would stay active in the soil.



Ron knew his target. But he didn't stop to think about his chemical weapon.

If you want to choose the right chemical you should know about the Registered Target. The Registered Target tells you which pest or pests the chemical will control.

Here is Roundup's Registered Target:

**Water soluble herbicide for non-selective control of many annual and perennial weeds in certain situations.**

**Clear as mud Isn't it?**

Don't give up. Look in the Glossary: Chemicals on the Farm and copy down the meanings of the following words.

soluble .....

non-selective .....

annual .....

perennial .....

Do you know more about the weeds that Roundup will control now?

**ACTIVITY**

Collect two examples of a perennial weed from your farm.

Can you identify them positively using a field guide or weed chart?

.....

Will Roundup control these weeds?

.....

The Roundup label says that Roundup will control many annual and perennial weeds "in certain situations".

What kind of situations might stop Roundup controlling weeds?

.....

.....



**10. Amount of Contents**

This tells you how much the Roundup container has in it.

Look at the label on page 5.

Roundup contains ..... litres.

## QUIZ ACTIVITIES

1. Straighten out the jumbled letters to make the right word.

(a) A warning on a chemical label

**sudhelec** .....

(b) The company that manufactures the product.

**tcafurseunma** .....

(c) The most important chemical in a pesticide.

**atcvei contitsneut** .....

(d) The part of the label that tells you which pest or pests the chemical will control.

**regsitdere ratteg** .....

2. Using the metropolitan phone book, find the addresses and phone numbers of the following companies.

Monsanto Australia Ltd.

.....  
.....

Nufarm Chemicals Ltd.

.....  
.....

Agricultural & Veterinary Chemicals Association of Australia.

.....  
.....



In your own words, briefly describe the different parts of this chemical label.

**POISON**

**NOT TO BE TAKEN  
KEEP OUT OF REACH OF CHILDREN  
READ SAFETY DIRECTIONS BEFORE OPENING**

**Ramrod** <sup>R</sup> **650**

SELECTIVE PRE-EMERGENCE HERBICIDE BY

**Monsanto**

Active constituent: 650g/kg PROPACHLOR

for control of annual grasses  
and certain broad-leaved weeds  
in sorghum and selected  
vegetable crops

Read 'Limit of Warranty and Liability' before buying or using

**PRIMARY PACK—CONTAINS 2x5kg MEASURE PACKS WHICH IT IS ILLEGAL TO SELL SEPARATELY**

**NET CONTENTS: 10kg**

Monsanto Australia Limited (Incorporated in Victoria) Agricultural Division:	
Victoria: 600 St. Kilda Road, Melbourne, 3004.	Phone: (03) 522 7122
New South Wales: 7 Help Street, Chatswood, 2067.	Phone: (02) 413 2966
Queensland: 19 Lang Parade, Milton, 4064.	Phone: (07) 870 8144
South Australia: 26 Greenhill Road, Wayville, 5034.	Phone: (08) 373 1000
Western Australia: 18 Howe Street, Osborne Park, 6017.	Phone: (09) 448 6500



## Spraying with Bob

One day Bob decided to spray some weeds.

After a quick look at the chemical label, he got to work.

He sloshed about a bucketful of pesticide into an empty spray tank, spilling a bit down the outside of the tank onto the ground.

He put the container back inside the woolshed, on the floor this time, instead of in the cupboard behind the wool press. He then drove down to the creek to fill up since the tank by the woolshed was empty. The creek was in flood, but he managed to fill the tank without spilling too much.

He wiped his wet hands on his shorts and had a cigarette.

"Better get started before it gets even windier," said Bob, hanging onto his hat.

When he finished spraying, Bob went straight in for afternoon tea.

That night he didn't feel too hungry, gave tea a miss, and went to bed early, complaining of a headache.

### Did Bob spray safely and effectively?

List some of the precautions for the safe handling of a dangerous spray that Bob should have taken.



## Other ways to control pests.

Chemical sprays are only one method of controlling pests.

Chemical sprays should be used as part of your total pest management strategy.

## Other methods of pest control you may use include:

- cultivation
- grazing/mowing/burning/drainage
- hand weeding
- mulching and composting
- companion planting/crop rotation
- green manure crops
- biological control by predators and parasites
- non-toxic sprays (eg. pyrethrum, garlic)

More information on these methods of pest control can be obtained from:

National Association for Sustainable Agriculture in Australia  
C/- Tim Marshall  
PO Box A366  
South Sydney 2000

ORGAV  
PO Box 124  
Upper Ferntree Gully 3156

Department of Agriculture  
Organic Farming Unit  
Attention: Ross Clarke  
PO Box 174  
Ferntree Gully 3156

Total Environment Centre  
18 Argyle Street  
The Rocks 2000

Australian Consumers Association  
Food Working Group  
57 Carrington Road  
Marrickville 2204

Conservation Council of Victoria  
247 Flinders Lane  
Melbourne 3000



A useful and up-to-date reference is *The Ultimate Organic Resource Guide*. Copies available from Dick McNeill, C/- Doubleday Research Inc., 195 Comleroy Road, Kurrajong 2758.

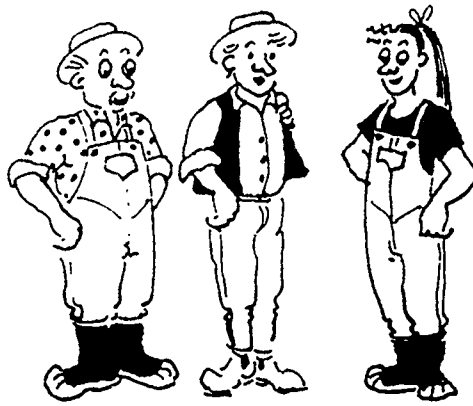

**(ii) Glossary:**  
**Chemicals on the Farm**

## Glossary: Chemicals on the Farm

<b>absorbed</b>	Taken in. Sucked up. Pesticides can be absorbed into the body through the skin, the mouth and the lungs.
<b>acaricide</b>	A chemical that kills mites, ticks and spiders.
<b>active constituent</b>	The chemical in a herbicide that causes it to kill pests (for example, Glyphosate in Roundup).
<b>adhesives</b>	Adhesives are added to sprays to help the spray stick on leaves and fruit.
<b>adjuvant</b>	Any substance that improves the performance of a mixture of sprays (for example, surface active agents, <i>adhesives</i> ).
<b>adulticides</b>	Chemicals that attack the adult insect.
<b>agitation</b>	Mixing, stirring.
<b>annual</b>	A plant that lives for only one year or season (for example, tomatoes, Paterson's Curse, peas). See also <i>perennial</i> .
<b>antidote</b>	A substance used to counteract the effects of a poison.
<b>aphicide</b>	A chemical that kills aphids.
<b>application</b>	Putting one thing onto another. The application of pesticides might involve: boom equipment, knapsack or handgun equipment, wiper equipment, controlled droplet application equipment, or aerial equipment.
<b>artificial respiration</b>	A first aid method used when breathing has stopped or is weak.
<b>aquatic</b>	To do with water. An <i>aquatic area</i> might be a dam or swamp.
<b>authorised</b>	Permitted, allowed.

<b>avoid</b>	Keep away from. Do not touch.
<b>back-siphoning</b>	When liquid flows back up the siphon.
<b>biological control</b>	Control of pests without using chemicals. Biological control involves the use of natural enemies (for example, rust fungus to control weeds).
<b>broadleaf weeds</b>	Weeds with wide leaves.
<b>combustible</b>	Explosive. Will catch fire easily.
<b>companion plants</b>	Plants which help crops to grow, usually by controlling pests (for example, the roots of marigolds give off a substance which drives away the eel-worm. They are therefore good companion plants for potatoes, tomatoes and roses).
<b>compatibility</b>	Chemicals are compatible if they can be mixed together without reducing their performance.
<b>compound</b>	A substance made up of two or more elements.
<b>consequences</b>	Results.
<b>consistent</b>	In agreement. Not being different.
<b>contact herbicide</b>	A chemical that kills those parts of the plant that grow above the ground (for example, leaves and flowers).
<b>contact insecticide</b>	A chemical that kills insects when it comes into direct contact with the insect.
<b>contaminate</b>	To poison. Incorrect use of pesticides may contaminate dams, soil, clothing, etc.
<b>contrary</b>	Opposite.
<b>corrosion</b>	The eating away of metal or other substances.

<b>crop establishment</b>	When the crop is planted and has begun to grow.
<b>cultivation</b>	To prepare land for growing crops. Cultivation (using hand hoes, rotary hoes, ploughs, discs and various forms of minimum tillage) is the traditional, mechanical method of weed control.
<b>defoliant</b>	A chemical that makes leaves drop off.
<b>delayed</b>	To take longer than expected.
<b>desirable plants and trees</b>	The plants and trees that you don't want to poison.
<b>dessicant</b>	A dessicant dries up plant leaves and stems.
<b>deteriorate</b>	To get worse.
<b>dilute</b>	To make weaker by adding water or other liquids.
<b>drift</b>	When spray or dust is carried away from the area being treated. Visible spray may drift as far as 100 metres, while <i>vapour</i> may drift several kilometres.
<b>edible</b>	Fit for animals to eat. (See also <i>non-edible</i> ).
<b>element</b>	A basic chemical substance (for example, oxygen, carbon).
<b>emerged</b>	Appeared above the ground.
<b>ensure</b>	Make sure that ...
<b>evaporation</b>	When water changes into a <i>vapour</i> .
<b>excessive</b>	Too much.

<b>fallow</b>	To leave land in an uncropped state for a period of time prior to sowing another crop.
<b>flash</b>	Sudden explosion.
<b>foliage</b>	The leaves of a plant.
<b>friable</b>	Crumbly soil.
<b>fumigant</b>	Any liquid or solid substance that forms <i>vapours</i> that destroy insects, bacteria, vermin, etc.
<b>fungicide</b>	A chemical to control fungi (for example, Bordeaux mixture).
<b>germination</b>	When a seed begins to grow shoots and roots.
<b>green manure crops</b>	A crop which is not harvested, but ploughed under green to improve the soil.
<b>herbage</b>	Non-woody plants (for example, grasses).
<b>herbicide</b>	A chemical to control weeds. A herbicide may be either selective (ie. killing the weeds only and not harming the crop), or <i>non-selective</i> (ie. killing all vegetation).
<b>ignite</b>	To light. Set fire to. Burn.
<b>impervious</b>	Won't let water or anything else in.
<b>inactivated</b>	Stops being effective. Doesn't work any more.
<b>incompatible</b>	Chemicals that will not mix together safely or effectively.
<b>incorporate</b>	To include.
<b>induce</b>	To make something happen. To "induce vomiting" means to make a person or animal vomit.

<b>infestation</b>	An infestation of pests means a great number of pests – an invasion!
<b>insecticide</b>	A chemical to control insects. Insecticides may kill insects through direct contact ( <i>contact insecticide</i> ), by being eaten (stomach poisons), or by gassing ( <i>fumigants</i> ).
<b>larvicides</b>	Chemicals that attack the insect when it appears as a grub, worm or larva.
<b>legislation</b>	Law.
<b>marginal seedbed conditions</b>	When the state of the earth is only just good enough to grow plants.
<b>maturity</b>	Full growth or development.
<b>meteorological conditions</b>	The weather conditions.
<b>miticide</b>	A chemical to control mites.
<b>molluscide</b>	A chemical to control snails.
<b>mulch</b>	Soil, straw, peat or any other loose material placed on the ground to prevent erosion, reduce moisture loss and prevent weed growth.
<b>nematicide</b>	A chemical to control nematodes (for example, roundworms, hookworms, etc.).
<b>non-edible</b>	Not fit for animals to eat.
<b>non-selective herbicide</b>	Kills all plants (including crops) with which it comes into contact. (See also <i>selective herbicide</i> ).
<b>non volatile</b>	Does not <i>evaporate</i> easily.



<b>ovicide</b>	Chemicals that attack the egg stage of insects.
<b>perennial</b>	A plant which continues growth from year to year. (See also <i>annual</i> ).
<b>pesticide</b>	A chemical to control insect, plant or animal pests. Pesticides can be liquids, powders, dusts, granules, baits or gases.
<b>post-emergent</b>	Spraying a crop after the plants' shoots have appeared. (See also <i>pre-emergent</i> and <i>pre-sowing</i> ).
<b>pre-emergent</b>	Spraying a crop after sowing <b>but</b> before the plants' shoots appear. (See also <i>post-emergent</i> and <i>pre-sowing</i> ).
<b>pre-sowing</b>	Spraying a seedbed before the crop is sown. (See also <i>pre-emergent</i> and <i>post-emergent</i> ).
<b>prior</b>	Earlier. Before.
<b>protectant fungicide</b>	A chemical that stops fungal spores infecting a plant (for example, copper spray).
<b>readily</b>	Easily.
<b>reduced</b>	Made less.
<b>residue</b>	Something that is left behind. A pesticide residue is an amount of any chemical used for the control of pests that remains in the soil or in plant or animal tissues.
<b>retarded</b>	Slowed down. Delayed.
<b>rhizome</b>	A root-like stem that grows underground producing both roots and shoots.
<b>rodenticides</b>	A chemical to control rodents.
<b>schedule</b>	The schedule on a pesticide label tells you how <i>toxic</i> the pesticide is.

<b>seedbed</b>	An area of land where seeds are sown.
<b>selective herbicide</b>	Kills certain weeds without harming other types of plants. Such herbicides select their target. (See also <i>non-selective herbicide</i> ).
<b>severe</b>	Harsh, serious, extreme.
<b>soluble</b>	Able to be dissolved.
<b>surfactants</b>	Chemicals that help the pesticide spread more evenly over the entire leaf. Often called a wetting agent.
<b>swath</b>	A strip of grass or crop.
<b>systemic chemical</b>	A chemical that moves through the plant's sap stream.
<b>thoroughly</b>	Completely. From top to bottom. To "wash skin thoroughly" means to wash with clean water for at least 15 minutes until the skin is completely clear of the chemical.
<b>toxic</b>	Poisonous or harmful.
<b>toxicity</b>	A measure of how poisonous a chemical is.
<b>translocated herbicide</b>	A herbicide which is sprayed on one part of a plant then moves to another part of the plant (for example, from the leaves to the roots).
<b>vapour</b>	Like a gas.
<b>visible</b>	Can be seen easily.
<b>volatile</b>	<i>Evaporates</i> easily and quickly. Changes easily into a <i>vapour</i> . (See also <i>non-volatile</i> ).

---

**water soluble**      Able to be dissolved in water.

**weed canopy**      The top layer of the weeds.

**withholding period**      The number of days you must wait between spraying and harvest, or spraying and grazing.

# The Spray-Rite Kit

## 2. Measuring for Spraying



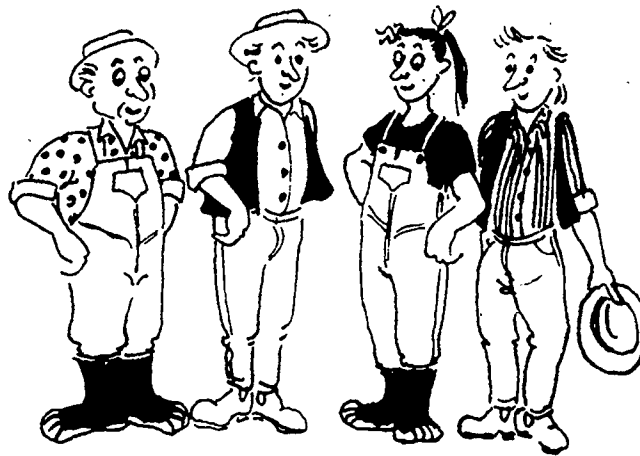

**(i) Measuring Length**



Have you ever stopped to think about the **measuring** you do every day?



How much cough mixture will I need to soothe my throat?



How much Roundup will I need to kill the weeds?

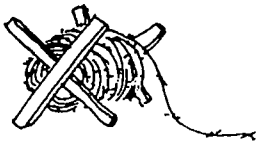

How much wire will I need to fix the fence?

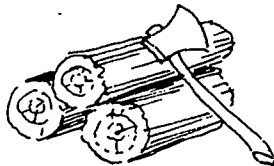

How long do I have to cut the logs to fit in the stove?



How much water will I need to mix this jelly?

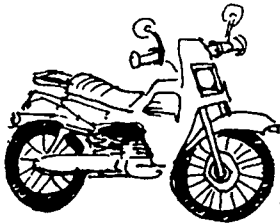

How much petrol will I need to get into town?



How much fertiliser will I need to cover this paddock?

You probably measure a number of things every day. Some things are simple to measure. It's pretty easy to roughly measure logs for your stove.

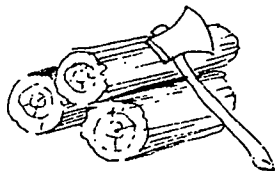

But other things – like using chemical sprays – require a bit more practise.



The **Measuring for Spraying** booklets will help you develop and practise your measuring skills. They will also help you understand metric measurements.



People on the land use measuring to solve problems that crop up every day.

To be a good problem solver you need to develop and practise two important measuring skills.

1. Measuring accurately
2. Estimating or measuring roughly.

### 1. Measuring accurately

Sometimes you need to measure accurately. Measuring accurately makes sure you use exactly the right amount.

Always measure accurately when you don't want to waste things by using too much or too little.

Using too much can be expensive.

Using too little can be ineffective.

If you use too little or too much Roundup the weeds won't die. If you use too much you may damage other areas.

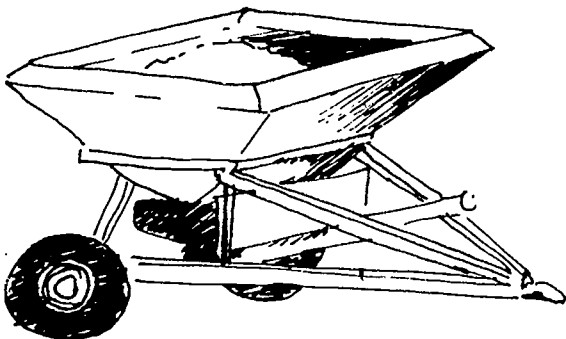

Fertilisers are expensive. Using too much will cost you money.

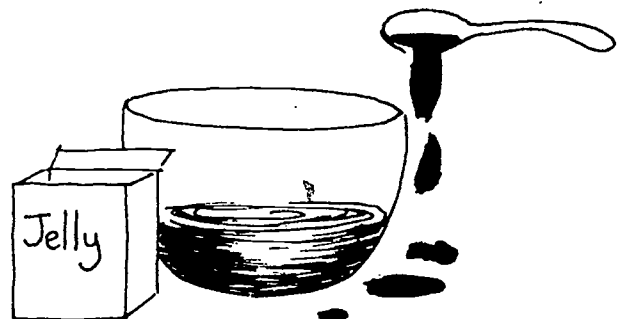

If you don't use enough jelly crystals the jelly won't set.



## 2. Estimating or measuring roughly

Sometimes you only need to measure roughly.  
Measuring roughly means *estimating* the amount you will need.

Estimate when you don't have measuring equipment handy.

Estimate when you want a rough idea of how much you will need  
or how much something will cost.

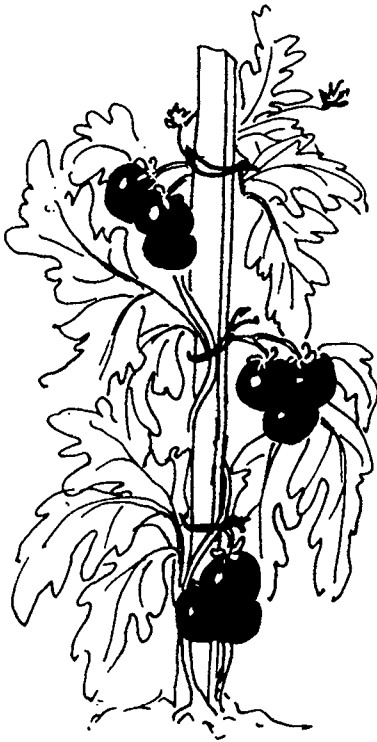
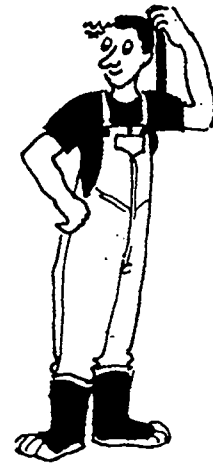

I'll probably need about  
10 metres of twine to tie  
up a dozen tomato plants.

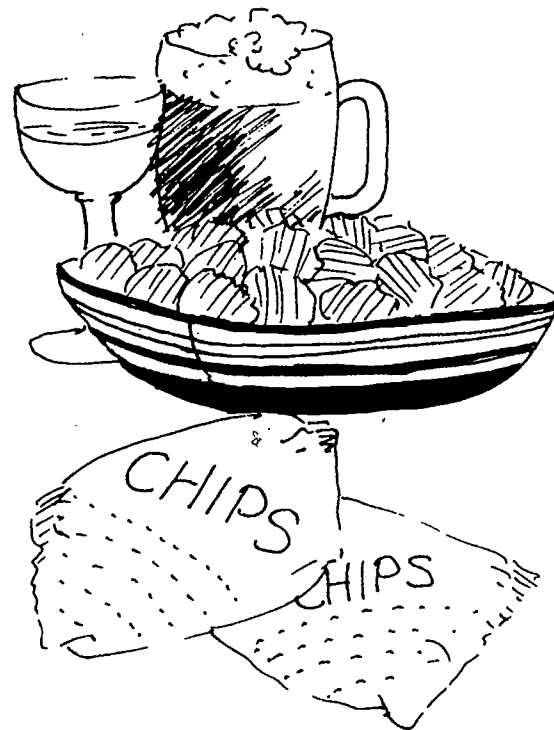

I'll need about 20  
packets of chips for  
tonight's party. (Or  
25 if John turns up!)

Look at these examples of measuring.

Tick the ones you would measure **accurately**.

Cross the ones you would measure **roughly**.



(a) cough mixture:

I need 100 ml of cough mixture



(b) logs:

I need medium-sized logs



(c) twine:

I need enough twine to tie up the tomatoes



(d) nails:

I need the 3cm nails

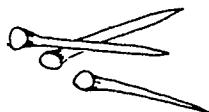

(e) polypipe:

I need exactly 46.5 metres of polypipe

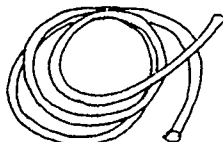

(f) chemicals:

I need to mix 75ml of Roundup with 15 litres of water



(g) wire:

I need about 3 metres to patch the hole in the gate



## WORKING WITH LENGTH

Have you ever been caught in the back paddock without your ruler or tape measure handy?

It's times like this that you need to be able to *estimate*.

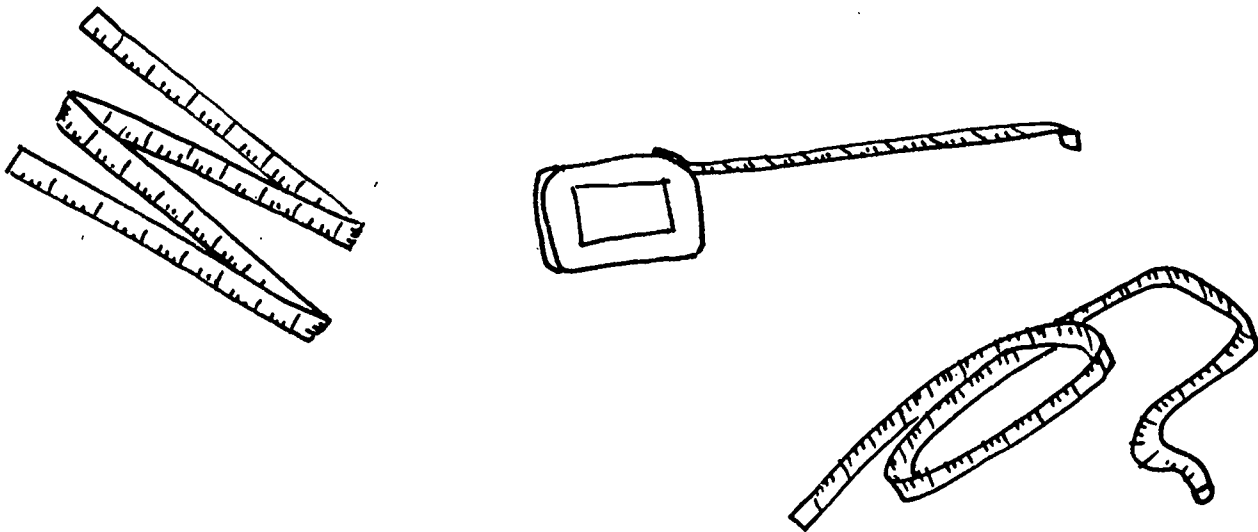
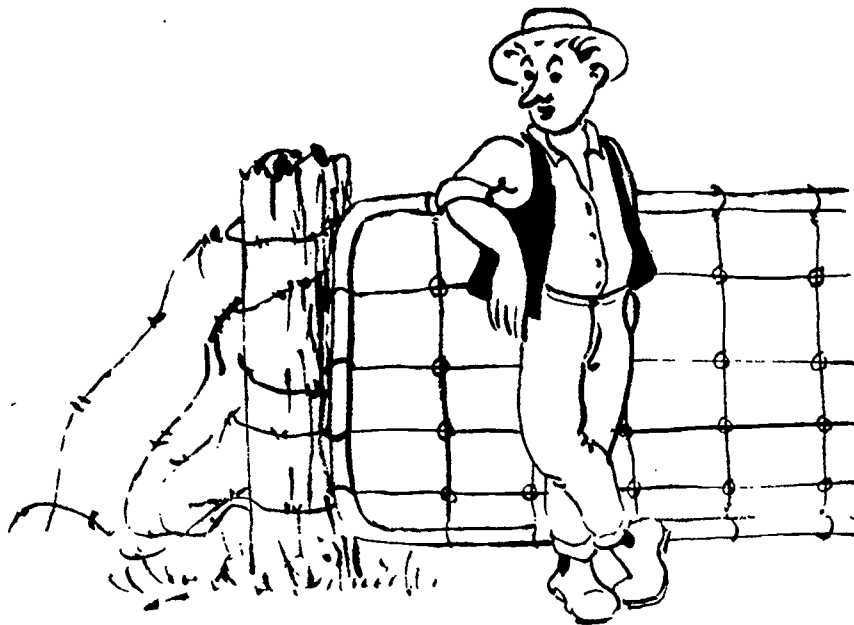

To work out the length of an object you need to be able to estimate some basic metric measures.

You need to be able to estimate 1 centimetre (1cm)

You need to be able to estimate 10 centimetres (10cm)

You need to be able to estimate 1 metre (1m)

Can you estimate 1 centimetre (1cm)?

Draw a line you estimate is 1cm long.  
Don't use a ruler.

Can you estimate 10 centimetres (10cm)?

Draw a line you estimate is 10cm long.

Can you estimate 1 metre (1m)?

Mark out a distance you estimate is 1 metre long.

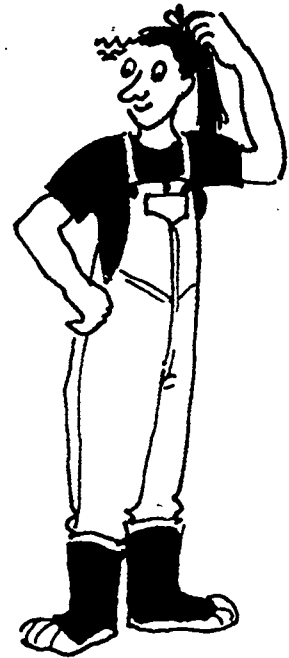

Now measure your lines with a ruler or tape measure. How accurate were you?

Did you under-estimate?

Yes

No

Did you over-estimate?

Yes

No

Were you spot-on?

Yes

No



The more you estimate, the easier estimating becomes. Practise your estimating skills and you'll be surprised how accurate you become.

Try estimating with Body Metrics.

Estimating length is easy using parts of the body. Use **body metrics** for estimating whenever you don't have access to a ruler or tape measure.

Find a fingernail which is about 1cm across.



Now use your finger to measure some common items.

eg.

a matchbox



a cigarette

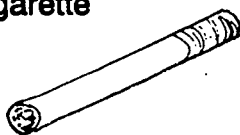

a door handle

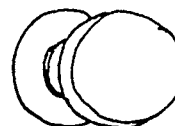

a paperclip

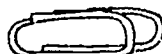

Start on the dot and estimate the lengths

5cm .

3cm .

6cm .

Use a ruler to check your accuracy.

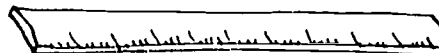

You should be able to estimate 1cm easily in future.

Now find a point on your hand which is 10cm across.

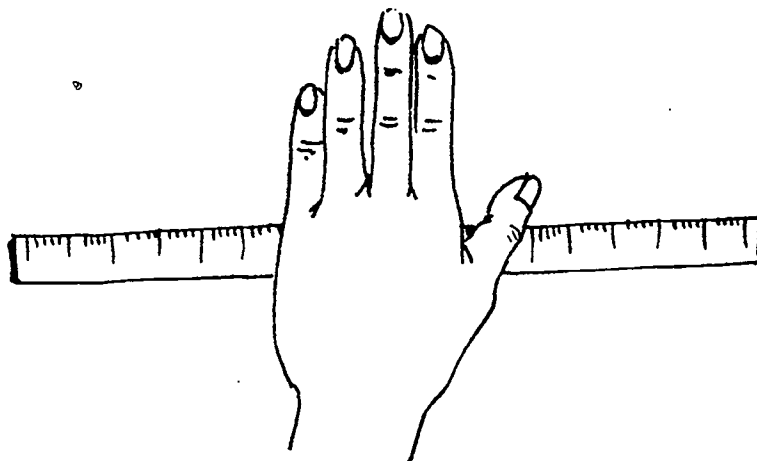

Use your hand to measure such items as:

• a pencil

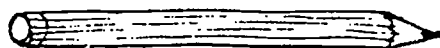

• a screwdriver

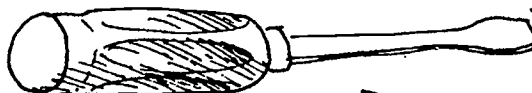

• the pages in this book

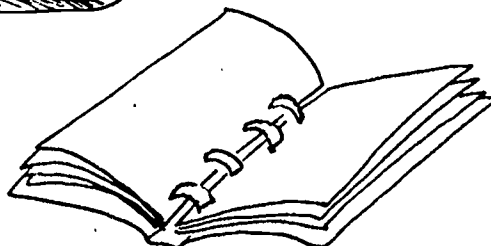

Start on the dot and estimate these lengths.

11cm .

15cm .

9cm .

Use a ruler to check your accuracy.

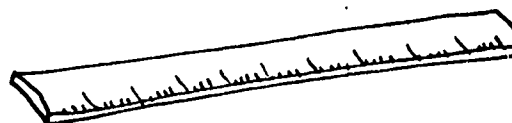

You should be able to estimate 10cm easily in future.

There are many other useful body measures that can help solve estimating problems.

Find out what your handspan measures.

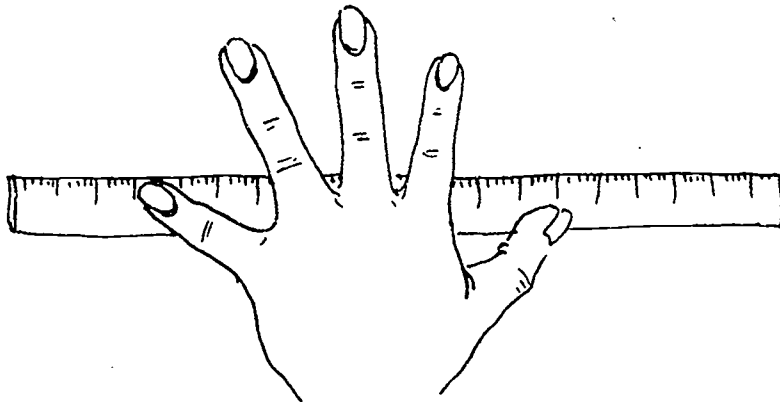

Find a point on your body which is 1 metre high.



Here are some other body metres.

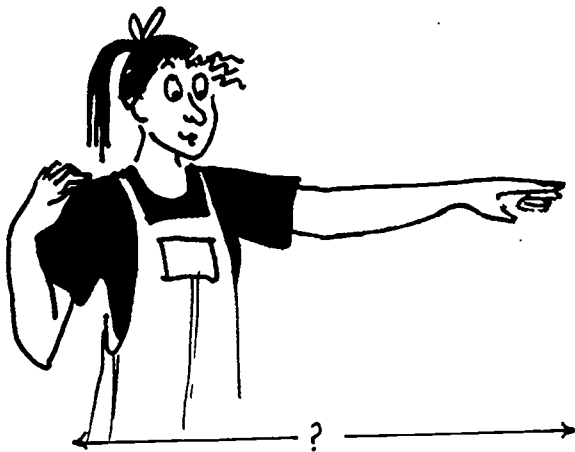

From right shoulder to the tip of your left hand.

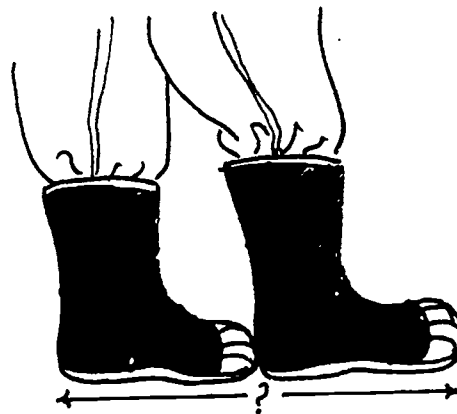

Back of your left foot to the tip of your right foot.

Use a body metre to measure the height of a door knob.

The door knob  
is approximately ..... cm.

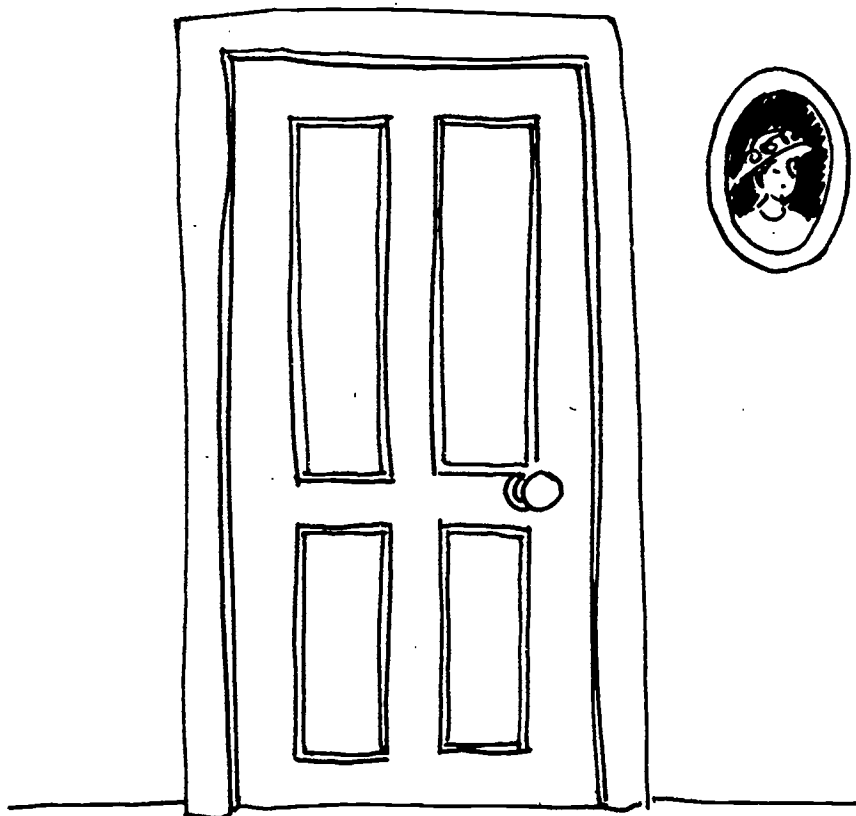

You should be able to estimate 1m easily in future.

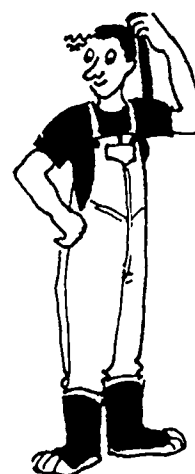



Now you have a chance to put your **body metrics** and estimating skills to the test.

Use your body metrics to estimate these lengths.

Check your accuracy using a ruler or a tape measure.

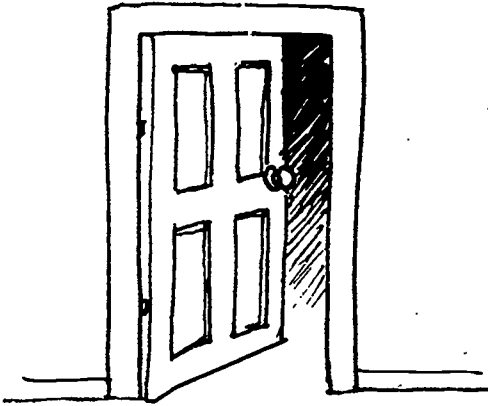

Using body metrics I estimate the door to be approximately ..... wide.

Using my tape measure I found the door to be exactly ..... wide.

My estimate was

a long way off

pretty close

spot-on

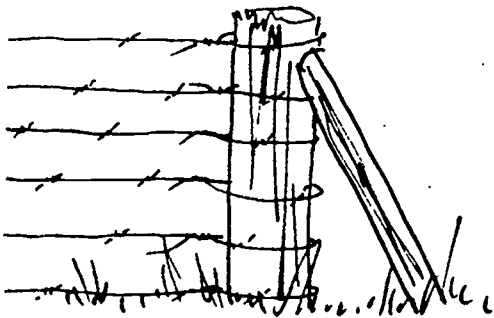

Using body metrics I estimate the post to be approximately ..... high.

Using my tape measure I found the post to be exactly ..... high.

My estimate was

a long way off

pretty close

spot on



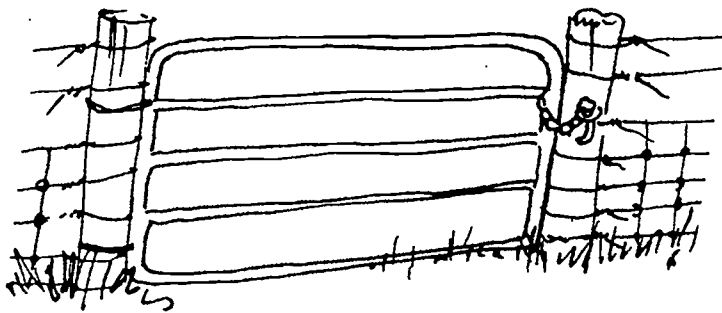

Using body metrics I estimate the gate to be approximately ..... long.

Using my tape measure I found the gate to be exactly ..... long.

My estimate was

a long way off

pretty close

spot-on



Using body metrics I estimate the weed to be approximately ..... high.

Using my tape measure I found the weed to be exactly ..... high.

My estimate was

a long way off

pretty close

spot-on



After all that estimating, how did you go?

Did you usually under-estimate or over-estimate?

Did you find it easier to estimate large or small objects.

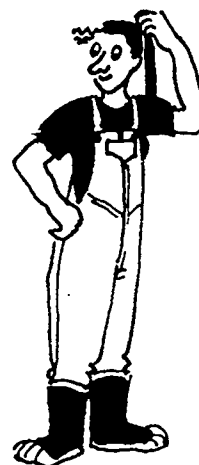

Estimating is a very useful skill. You should be well on the way to being a good estimator now. Keep practising. The more you estimate, the easier it becomes.



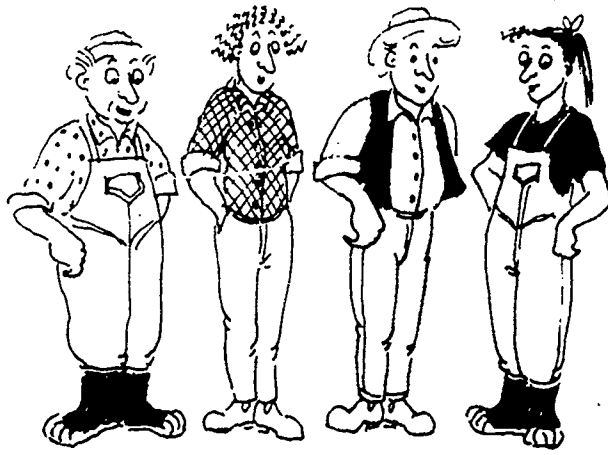

**(ii) Measuring Perimeter**

In the last section we concentrated on length. You practised estimating lengths using body metrics and measuring lengths accurately using rulers or tape measures.

In this section we concentrate on using your length measuring skills to work out perimeter problems.

Perimeter is the total length around the outside of a shape.

If you can find out the perimeter of a shape you will be able to solve some problems quickly.

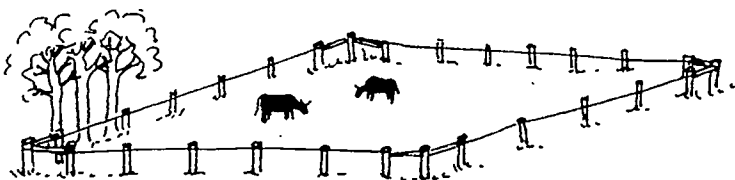

The perimeter of this paddock is 100 metres. I will need 100 metres of wire to fence the boundary with one strand.

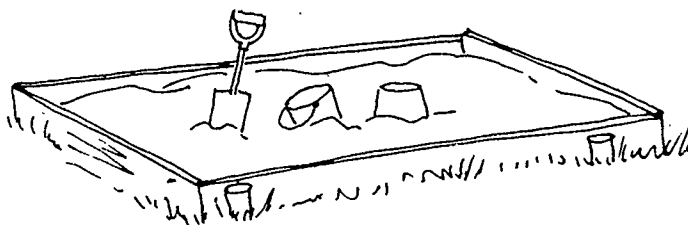

The perimeter of the sandpit is 8 metres. I will need 8 metres of plant to go around the edge.

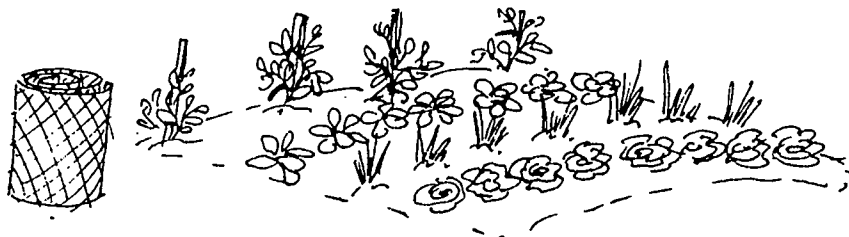

The perimeter of the vegie garden is 12 metres. I will need 12 metres of mesh to fence it off.

How do you calculate perimeter?

# Calculations

Finding the perimeter of a shape is dead easy!

Using a ruler, measure each side of this square and write the answers in the boxes below.

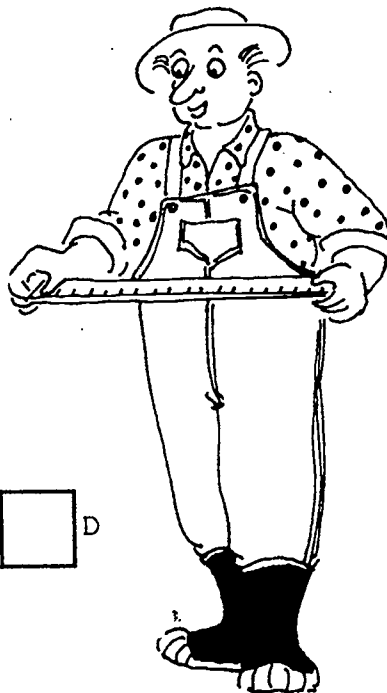
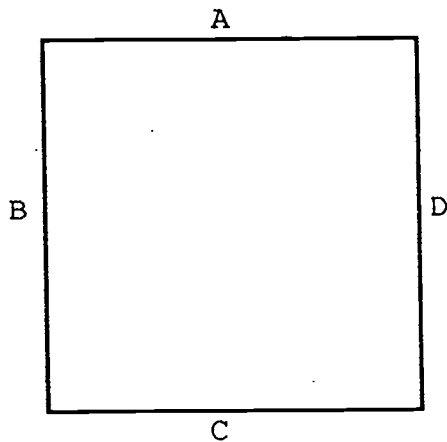

A

B

C

D

Now simply add up each side.

$$A + B + C + D =$$

You have just worked out the perimeter of this square.

The perimeter is simply the **Sum of all the Sides**. Remember it like this:

**P = S.O.S. (Perimeter = Sum of all the Sides)**

Measure the shapes below and write the perimeter inside.

Look at the aerial photograph of Ron and Carol's farm. There are two paddocks that need fencing.

The length of each side of the paddocks are marked in metres.

Find the perimeter of each paddock.

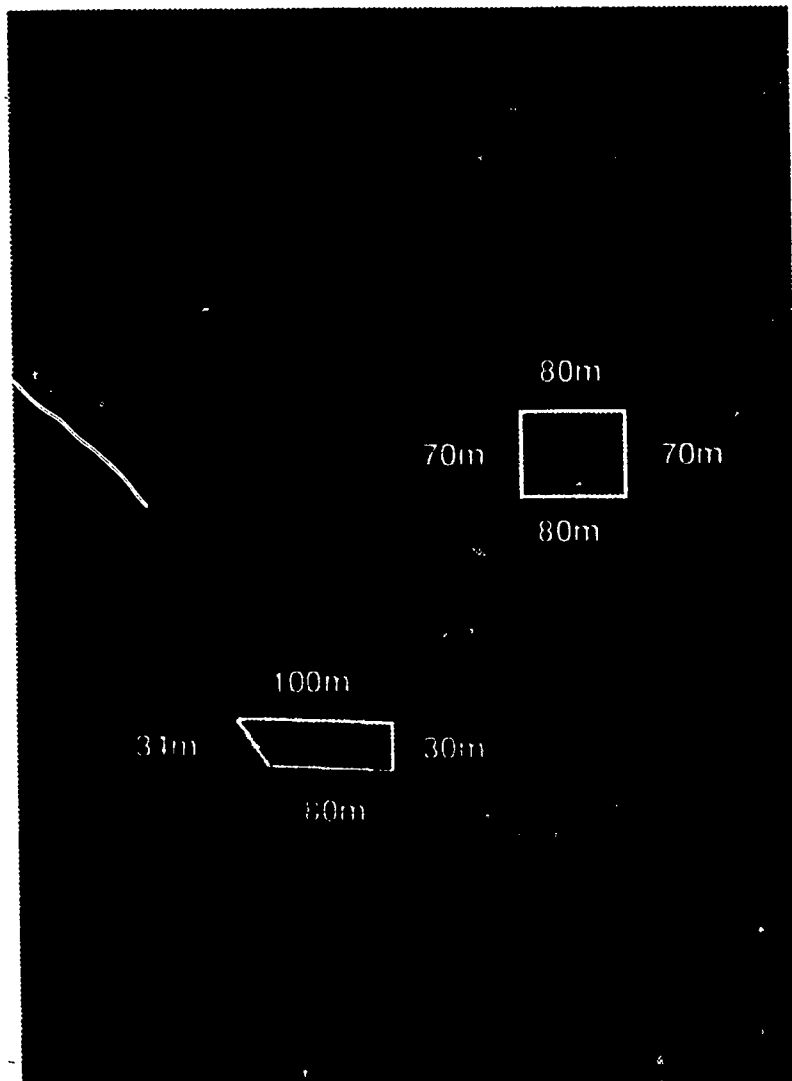

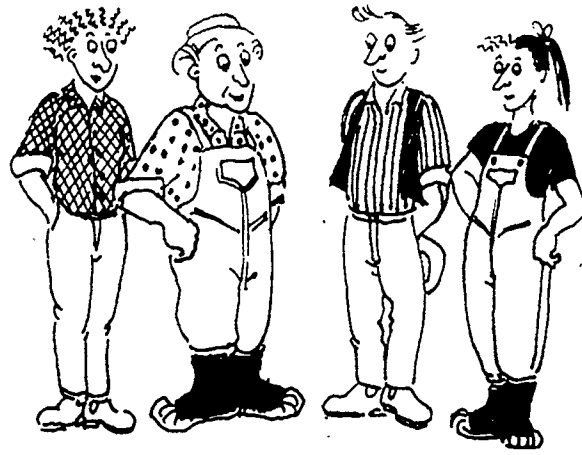

**(iii) Measuring Area**



Knowing how to calculate the perimeter of a shape is a very useful measuring skill. But being able to work out perimeter won't solve all your farm measuring problems.

Sometimes you will need to work out the area of a shape.

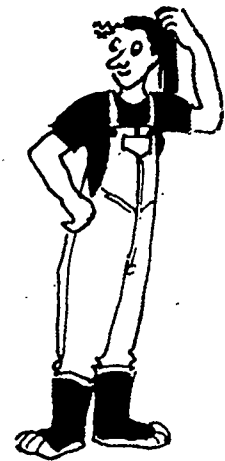
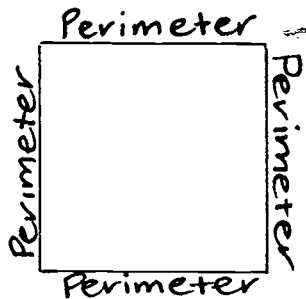

If you can find out the area of a shape you will be able to solve some problems quickly.

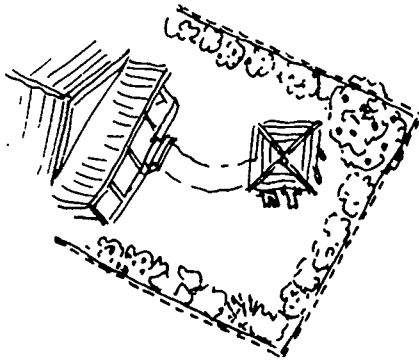

What is the area of the back yard so I can cover it with lawn seed?

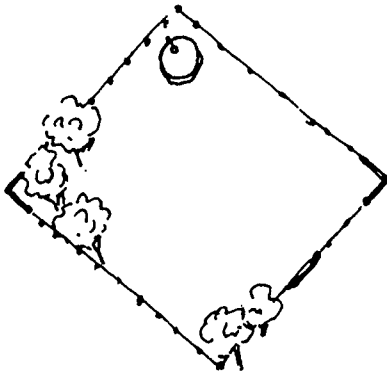

What is the area of the paddock so I can work out how much spray to use to control the weeds.

If you get these calculations right you will use exactly the right amount of seed or spray. This will save you time and money.

Using too much can be expensive.

Using too little can be ineffective.

So how do you calculate area?

To calculate the area of a square, measure two sides and write the answers in the boxes below.

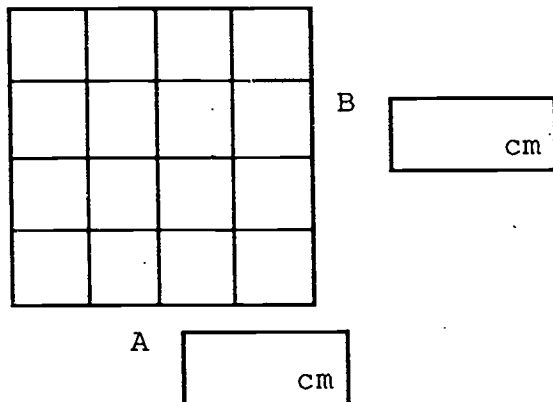

Now simply multiply these together.

$$A \times B = \text{..... cm}^2$$

You have found the area of this square. Now count each small square. Your answer should be the same.

Notice that your answer has  $\text{cm}^2$  written after it.

This symbol indicates you have measured the area of the square in *square centimetres*.

There is a simple rule for finding the area of a square.

$$A = S \times S$$

$$\text{Area} = \text{Side multiplied by Side}$$



Multiply the two sides together and you have calculated the area of a square.

To calculate the area of a rectangle you need to measure two sides, just like you did for the square.

**BUT**, you need to measure one long side and you need to measure one wide side.

Measure the length and width of this rectangle and write the answers in the boxes below.

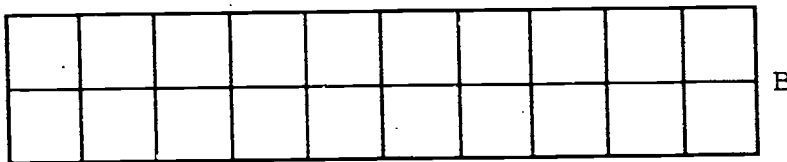

A

cm

cm

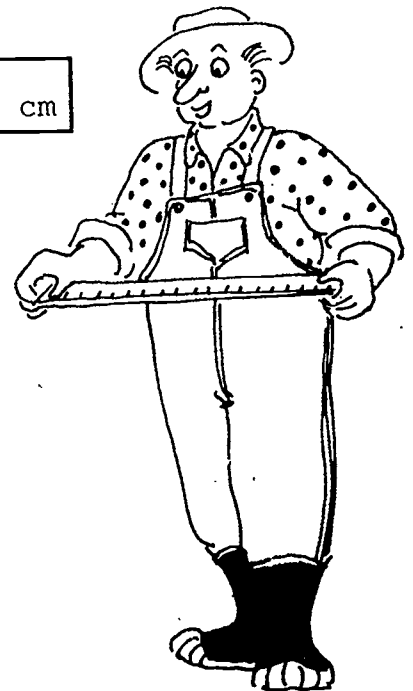

Now simply multiply these together.

$$A \times B = \text{..... cm}^2$$

**Congratulations!** You have found the area of this rectangle. Now count each small square. Your answer should be the same.

The rule for calculating the area of a rectangle is simple.

$$A = L \times W$$

Area = Length multiplied by Width

Simply multiply the length of a rectangle with its width and you have calculated its area.

Measure the squares and rectangles below and calculate their areas.

Don't forget to include  $\text{cm}^2$  after your answers.

Count the small squares inside each shape to check your answers.

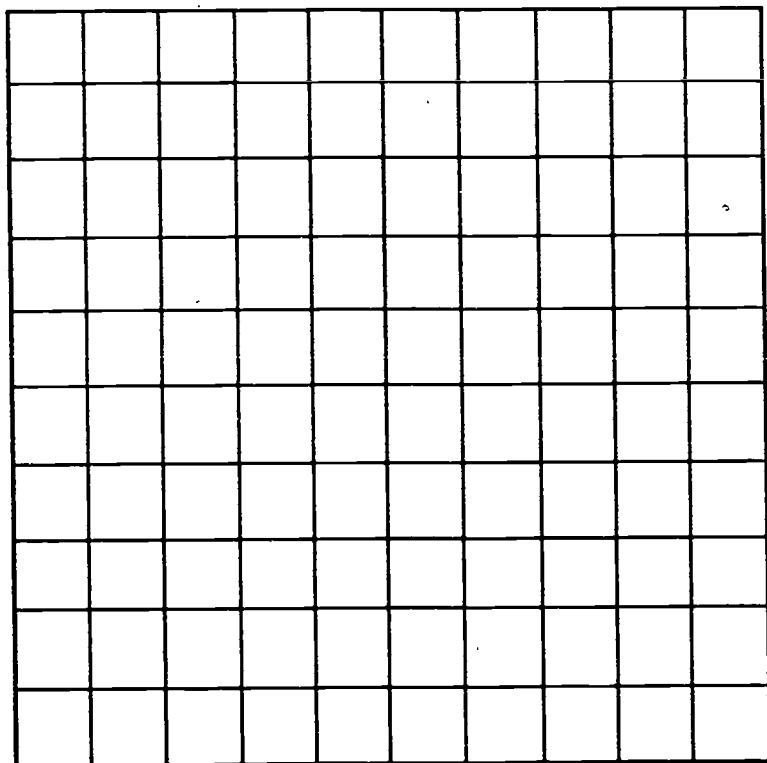
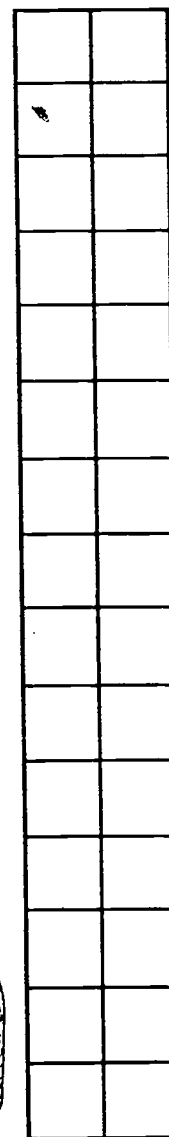
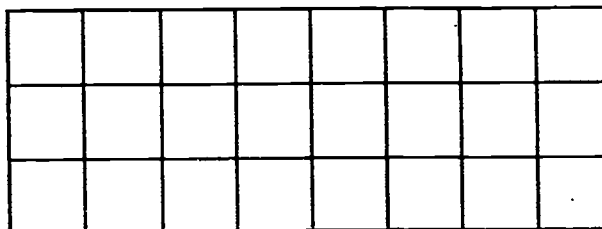
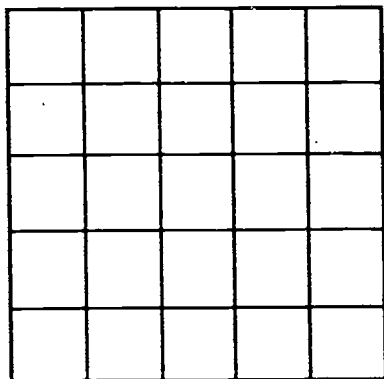

So far you have calculated the area of several squares and rectangles using square centimetres ( $\text{cm}^2$ ).

But is it always appropriate to use square centimetres?



Very large areas and very small areas need to be calculated in appropriate square measurements.

These are the other common metric square measures.

square millimetres  
square metres  
hectares

$\text{mm}^2$   
 $\text{m}^2$   
ha

Square millimetres ( $\text{mm}^2$ ) are used by

engineers  
draftspeople  
electricians  
fitters and turners  
watchmakers



A watchmaker needs to leave an area empty to fit the tiny battery into. This area would be calculated in square millimetres ( $\text{mm}^2$ ).

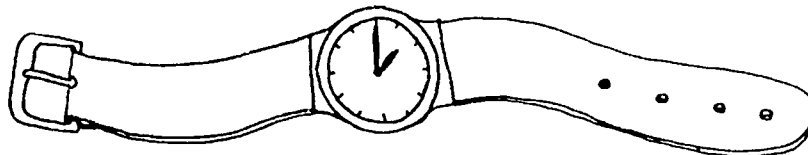

**Square metres (m<sup>2</sup>) are used by**

**builders  
landscape gardeners  
carpet layers  
house renovators**



**A carpet layer needs to know the area and shape of a room. They have to calculate the amount of carpet required to minimise waste. This area would be calculated in square metres (m<sup>2</sup>).**



**Hectares (ha) are used for land measurements. They are used by**

**property developers  
surveyors  
lands department officers  
real estate agents  
farmers**



A farmer needs to know the area of each paddock to stock it correctly. This area would be calculated in hectares (ha).

It is important to calculate area using the appropriate square measure.

To get a better idea of the area covered by a square millimetre ( $1\text{mm}^2$ ) try drawing one.

\* Draw your  $1\text{mm}^2$  here.

\* Now try drawing a square centimetre. Draw your  $1\text{cm}$  here.

\* Go outside and try drawing a square metre ( $\text{m}^2$ ) in the dirt.  
Measure it to check your accuracy.

\* To get a better idea of the area covered by a hectare (ha) try stepping one out.

**One hectare (ha) equals  $100\text{m} \times 100\text{m}$**

Go outside to a corner of a paddock.

Start in the corner and step out 100 metres along the fence line.

Mark this point so you can easily see where 100m ends.

Now go back to the corner and step out 100 metres of fence line in the other direction.

Mark this spot clearly too.

Do you have an idea now of how big a hectare is?

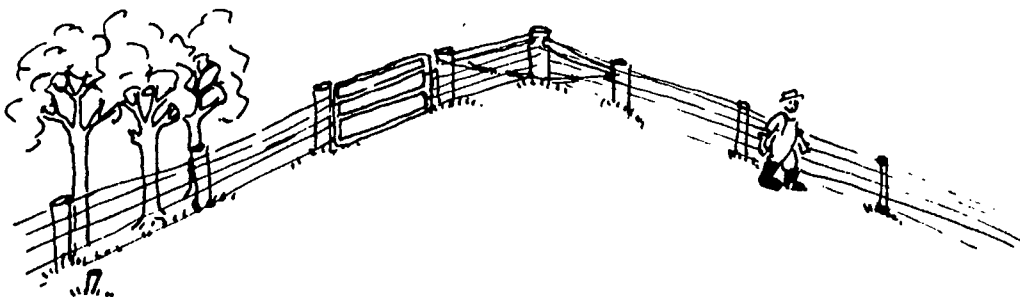



Which square measure would you choose to measure these areas?

For example, I would use  $\text{cm}^2$  to calculate the area of a 50 cent piece.

1. I would use \_\_\_\_\_ to calculate the area of this booklet.
2. I would use \_\_\_\_\_ to calculate the area of a house block.
3. I would use \_\_\_\_\_ to calculate the area of a watch winder.
4. I would use \_\_\_\_\_ to calculate the area of a housing estate.
5. I would use \_\_\_\_\_ to calculate the area of glass in a window.
6. I would use \_\_\_\_\_ to calculate the area of a postage stamp.
7. I would use \_\_\_\_\_ to calculate the area of a shed's wall.
8. I would use \_\_\_\_\_ to calculate the area of 2 large paddocks.





People on the land usually solve farm area problems using square metres (m<sup>2</sup>) or hectares (ha).

Look at the aerial photograph of Ron and Carol's farm. Calculate the area of the two bottom paddocks using square metres (m<sup>2</sup>).

Remember – use the rule for calculating area.

$$A = L \times W$$

Area = Length multiplied by Width.

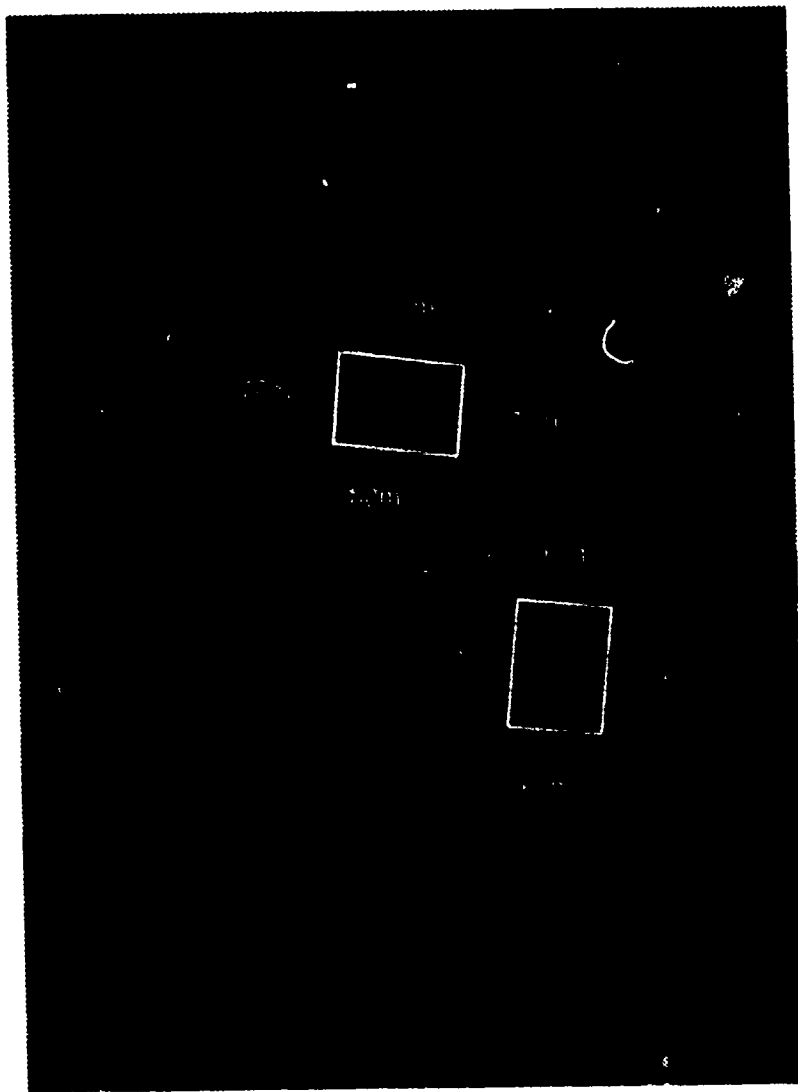

BEST COPY AVAILABLE

These paddocks sound pretty big!

But are they really?



Remember you have calculated the number of square metres that would fit side by side, row by row on the surface area of these paddocks. This explains why there are thousands of them.

To make the numbers a little easier to picture, try converting them to hectares.

A hectare has an area of  $10,000\text{m}^2$

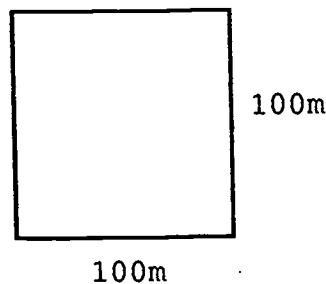

It is quite difficult to imagine tens of thousands of square metres, so when things get too big it is much easier to think in hectares.



Converting or changing square metres into hectares is fairly easy. Just follow these steps.

**Step one:**

Calculate the area using the  $L \times W = A$  rule.



11 000 m<sup>2</sup>!  
Those paddocks didn't  
seem that big last time  
I looked.

**Step Two:**

Divide the area by 10,000.  
10,000 is the number of square metres you need to make up one  
hectare.

1.1ha. That sounds more  
like it!



BEST COPY AVAILABLE

Calculate the area of these shapes and convert to hectares.

Don't forget to follow the steps above.

Write the area in hectares (ha) inside each shape.

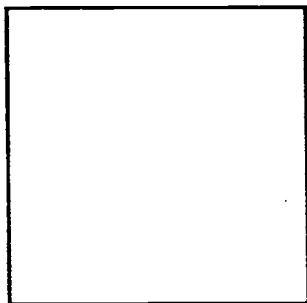

200m

200m

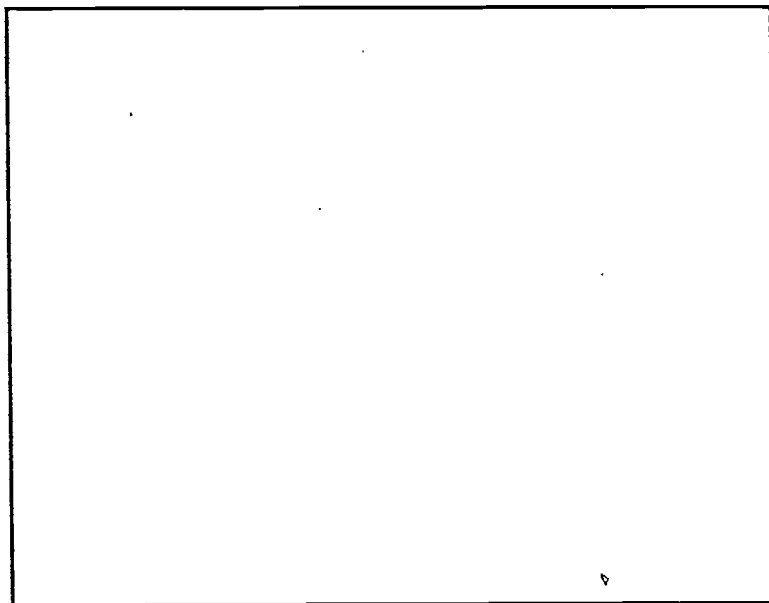

400m

500m

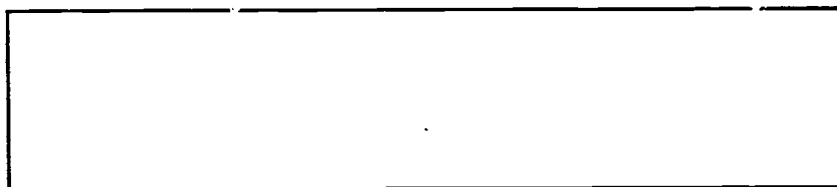

100m

550m



So far we have calculated the area of square and rectangular shapes. But as every farmer knows, not all paddocks are perfect squares or rectangles.

*Life wasn't meant to be that easy!*

Look carefully at the aerial photograph again.

How many perfectly square or rectangular paddocks can you count?

How many irregular shaped paddocks can you count?

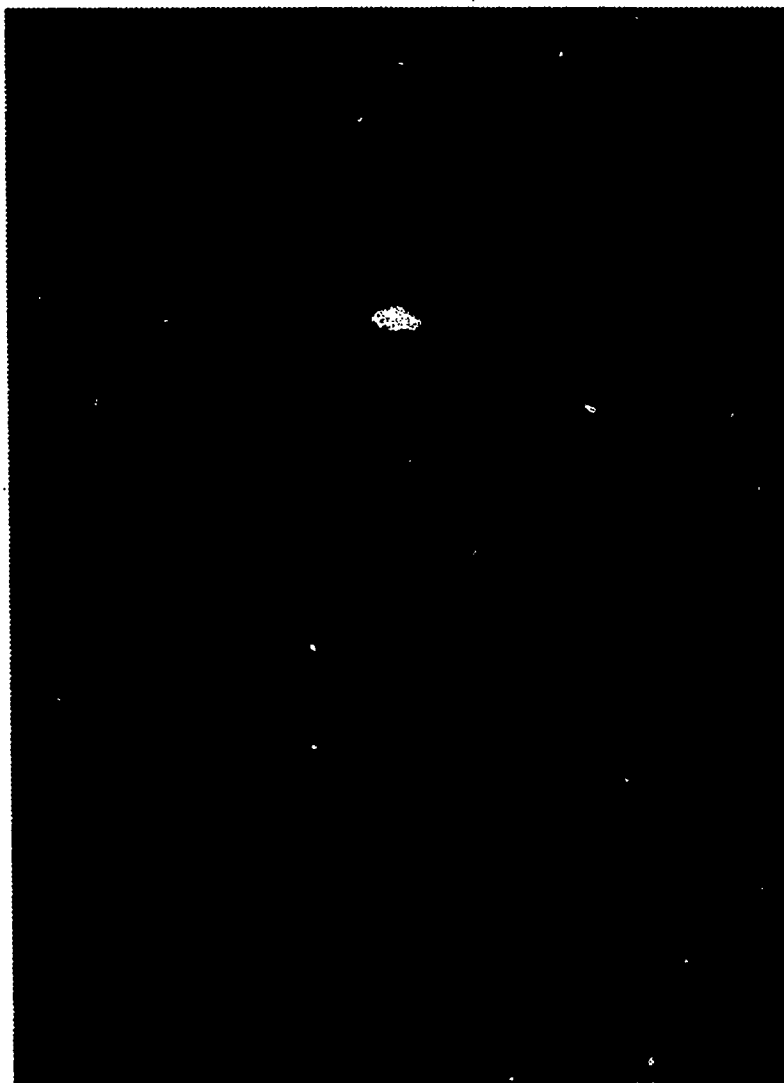

Calculating the area of odd shapes is fairly easy.

You need to attack the problem step by step.

Here is a simple example to work through.

This is the floor plan of Ron and Carol's lounge room.

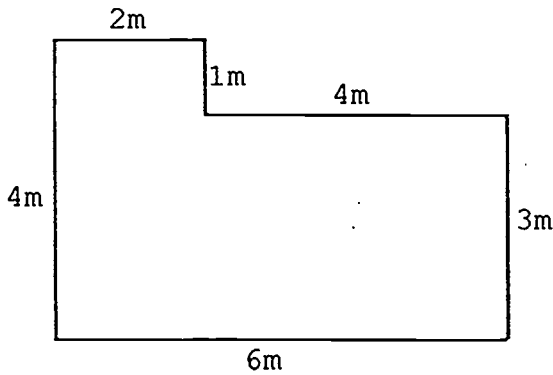

To calculate the area of this lounge room, you need to complete 4 steps.

**Step one:**

Look at the L shape.

Find the smaller squares or rectangles that make up the whole shape.

In this case, the L shape is made up of two rectangles of different sizes.

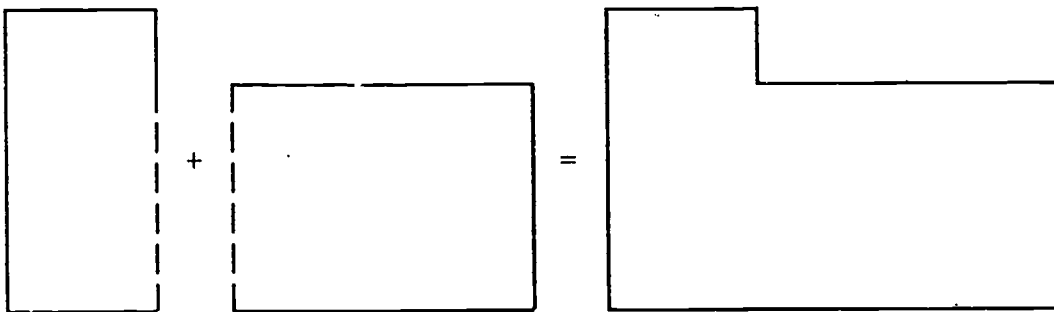

**Step two:**

Calculate the area of the largest rectangle.

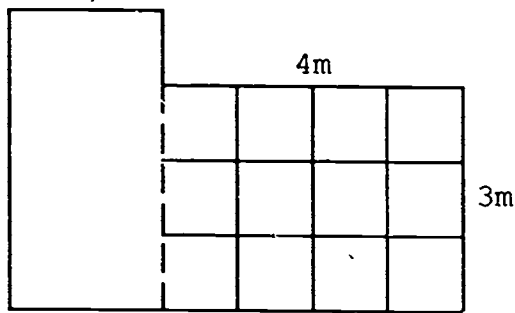

Count the squares in this rectangle to check your accuracy.

**Step three:**

Calculate the area of the smaller rectangle.

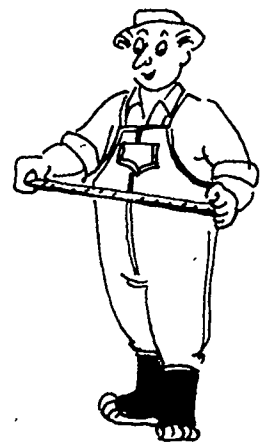
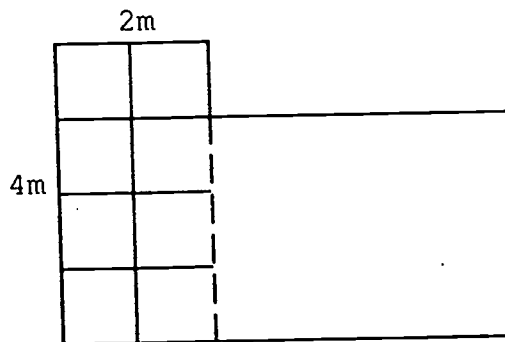

**Step four:**

Add the area of the large rectangle to the area of the small rectangle.

This will give you the total area.

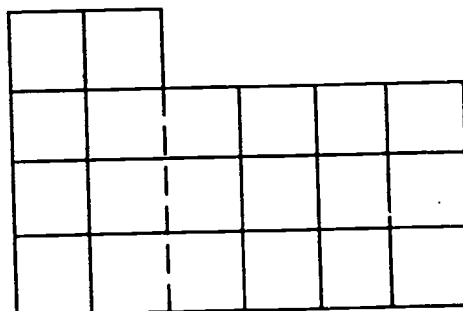

The total area of the living room is  $20\text{m}^2$ .  
Count the squares to check your accuracy.

Unfortunately, following these 4 steps wont solve all of your problems all of the time. What happens if your paddocks are **very odd shapes!**?

The aerial map of Ron and Carol's farm shows that many of their paddocks have odd angles.

Look at this one for example.

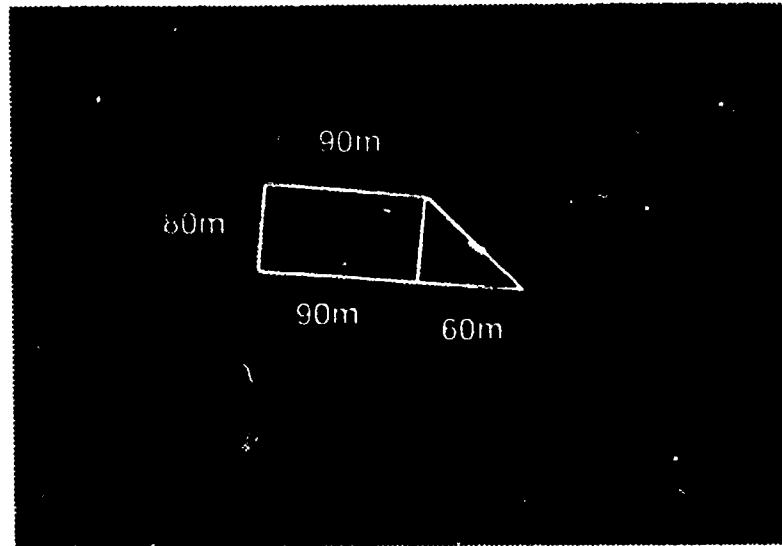

In this case the shape of the paddock is made up of a rectangle and a triangle, instead of another rectangle or square.

Attack these problem paddocks in the following way.

**Step one:**

Look at the shape of the paddock.

Find the triangle in the shape and mark it in.

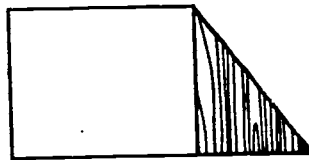

**Step two:**

Measure the length and width of the rectangle.

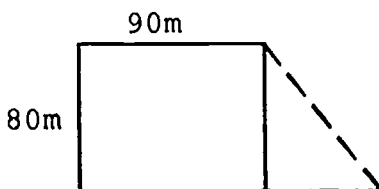



**Step three:**

Calculate the area of the rectangle.

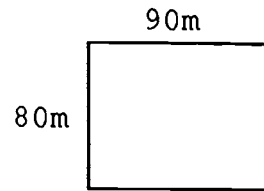

$$80 \times 90 = \dots\dots\dots \text{m}^2$$

At this point, you know the area of most of the shape, but what about the triangular part of the paddock?

You will need to calculate the area of the triangular part of the paddock too to find the total area of the shape.

How do you calculate the area of a triangle?

**Just apply another rule!**

The rule for calculating the area of a triangle is quite simple.



$$\mathbf{B \times H \times 0.5 = A}$$

Base x Height x 0.5 – Area

Below is a simple example.

Use the rule to calculate the area of the triangle.

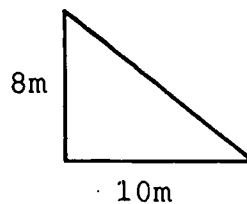

$$10 \times 8 \times 0.5 = \dots\dots\dots \text{m}^2$$

**Well done!** You have calculated the area of this triangle.

Now let's get back to our paddock problem.

**Step four:**

Measure the base and height of the triangle.

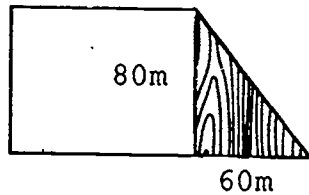

**Step five:**

Calculate the area of the triangle.  
Don't forget to use the rule.

$$\text{Base} \times \text{Height} \times 0.5 = \text{Area}$$

$$60 \times 80 \times 0.5 = \dots\dots\dots \text{m}^2$$

**Step six:**

Add the area of the rectangle to the area of the triangle to find the total area of the shape.

$$7,200\text{m}^2 + 2,400\text{m}^2 = 9,600\text{m}^2$$

**Step seven:**

To convert this to hectares, divide the answer by 10,000. Remember one hectare equals  $100\text{m} \times 100\text{m} = 10,000\text{m}^2$ .

$$9,600 \text{ divided by } 10,000 = 0.96 \text{ hectares}$$

**Here are those steps again.**

- Step one:** Find the triangle in the shape and mark it in.
- Step two:** Measure length and width of the rectangle.
- Step three:** Calculate the area of rectangle.
- Step four:** Measure the base and height of the triangle.
- Step five:** Calculate the area of the triangle using the rule  $B \times H \times 0.5 = A$ .
- Step six:** Add the two areas together to find the total area of the shape.
- Step seven:** Divide your answer by 10,000 to convert to hectares.



Calculate the area of these irregular shapes.

Don't forget to follow the steps.

Write the total area in each shape.

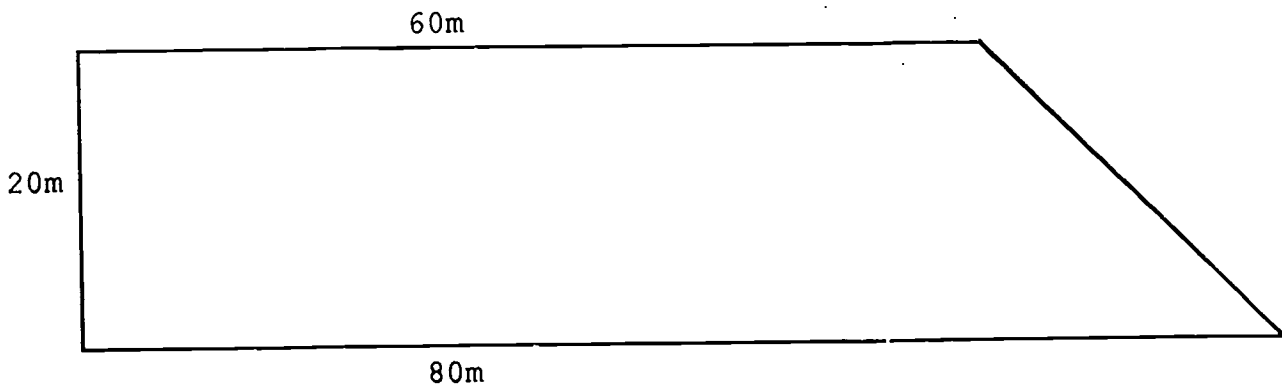
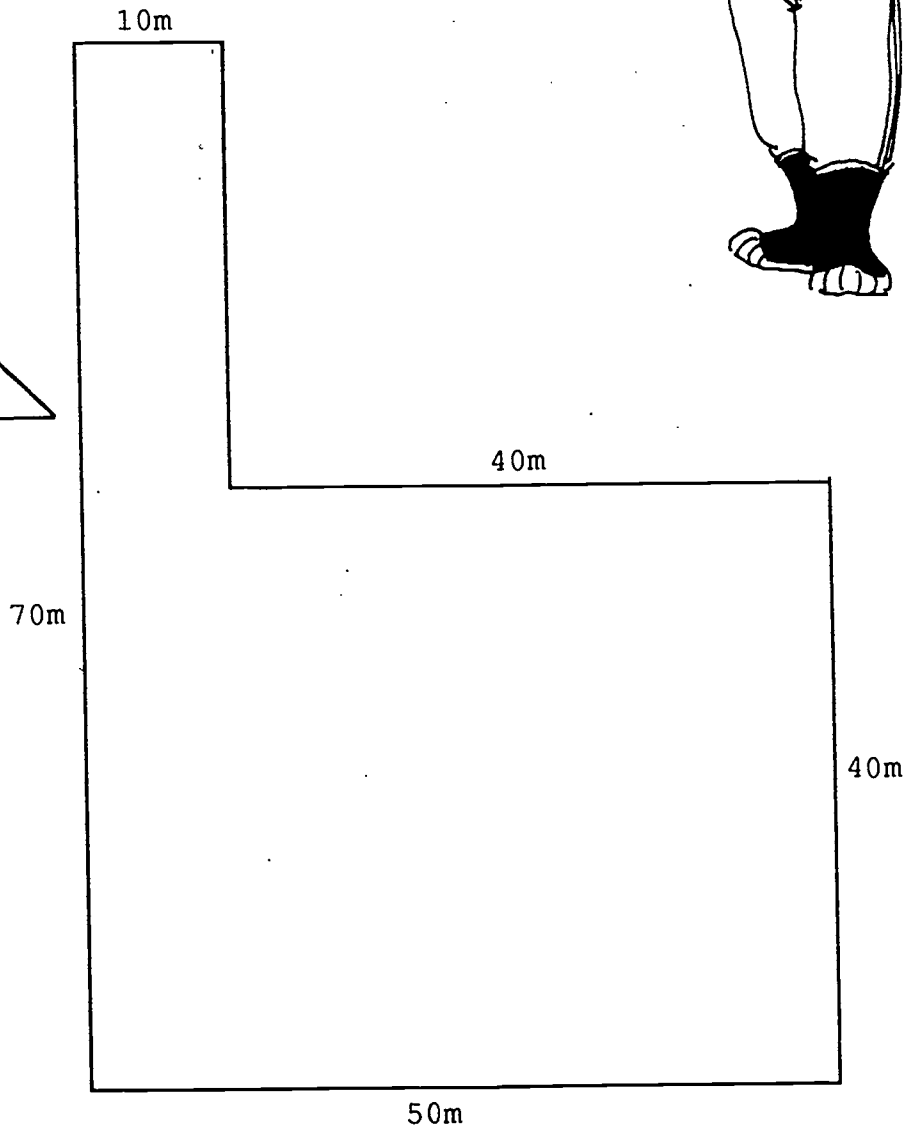
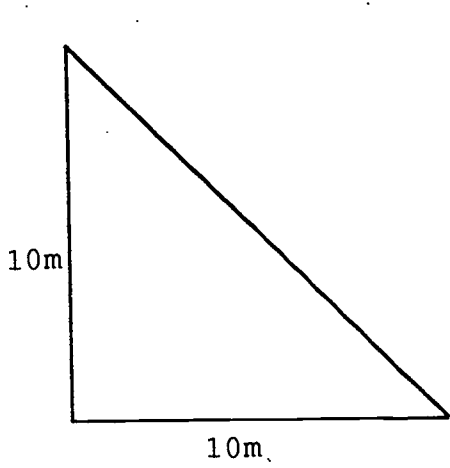
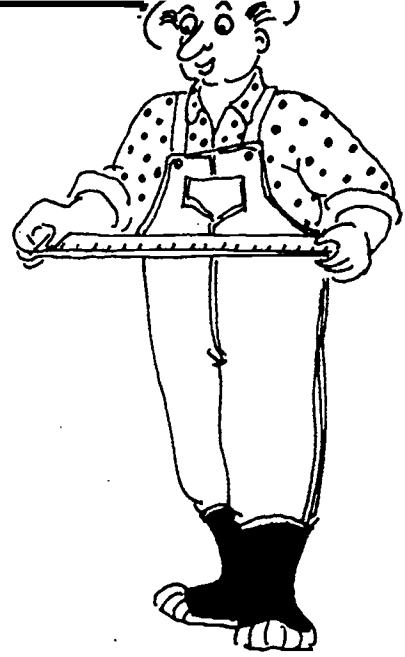

In this section you have learnt to calculate the area of squares.

$$S \times S = A$$

Side x Side = Area

In this section you have learnt to calculate the area of rectangles.

$$L \times W = A$$

Length x width = Area

In this section you have learnt to calculate the area of triangles.

$$B \times H \times 0.5 = A$$

Base x Height x 0.5 = Area

In this section you have learnt to calculate the area of odd shapes.



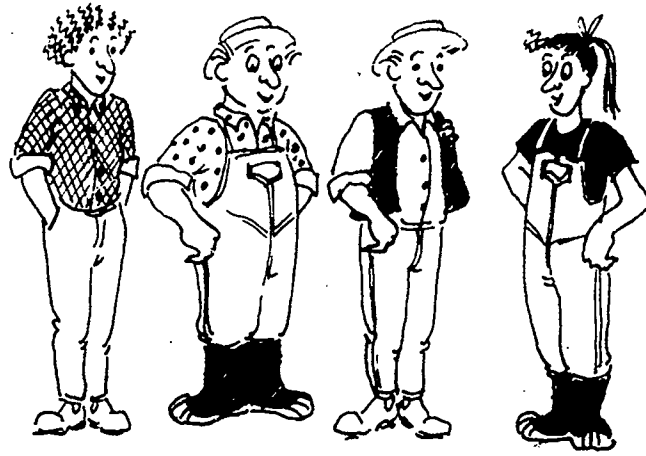

## **(iv) Measuring Liquids**

Think about your home and your farm.

Think of all the things around the place that you can fill with liquids.

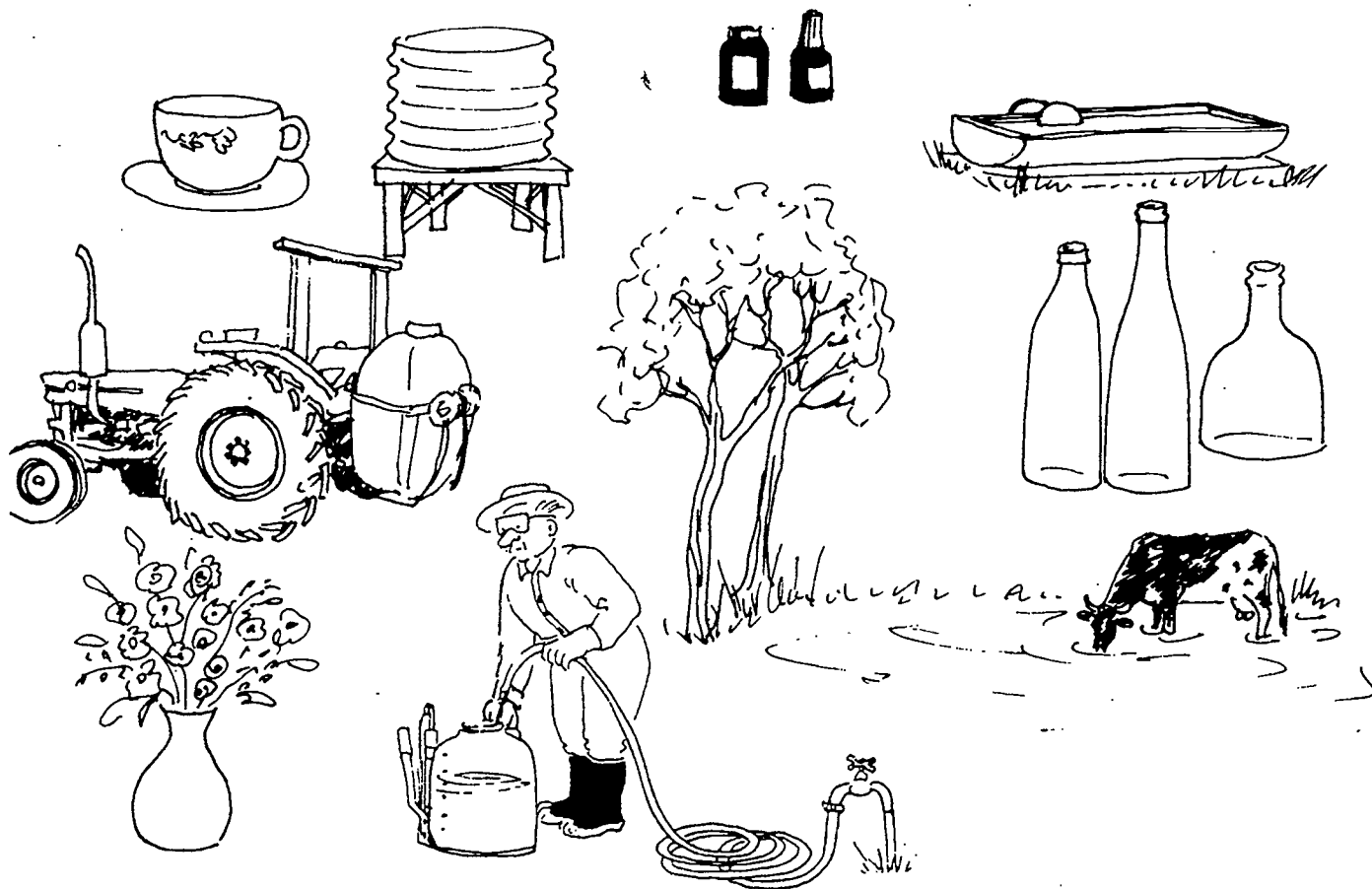

Sometimes you need to fill things up accurately. You need to measure exactly.

Sometimes you can guess.

When mixing chemicals it is important to measure very accurately.

### REMEMBER

Sprays are expensive. You don't want to waste them by using too much or too little.

Sprays contain poisons. You want to protect yourself, your family, your neighbours, your land, stock and crops.



Liquids are usually measured in litres or millilitres.



1 litre (l) = 1000 millilitres (ml)

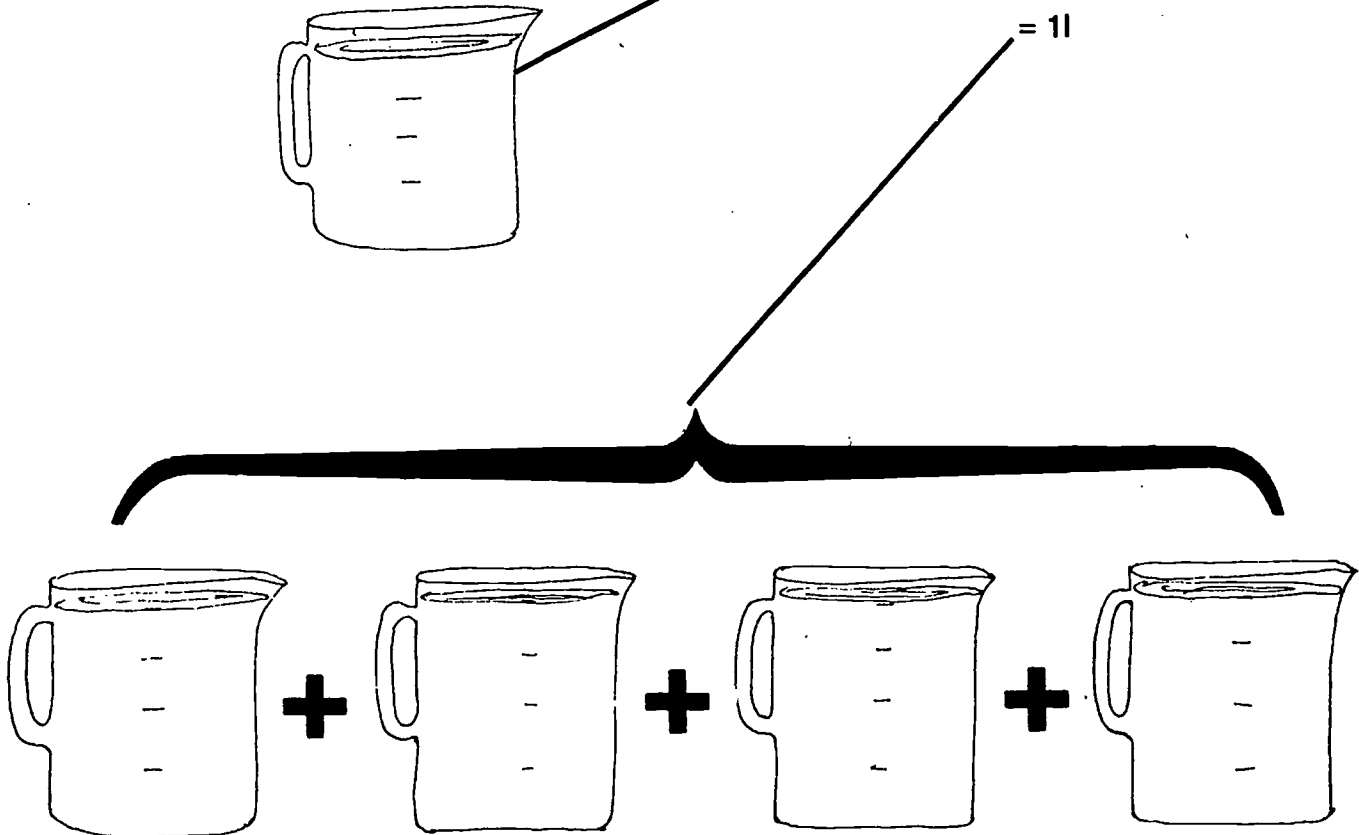
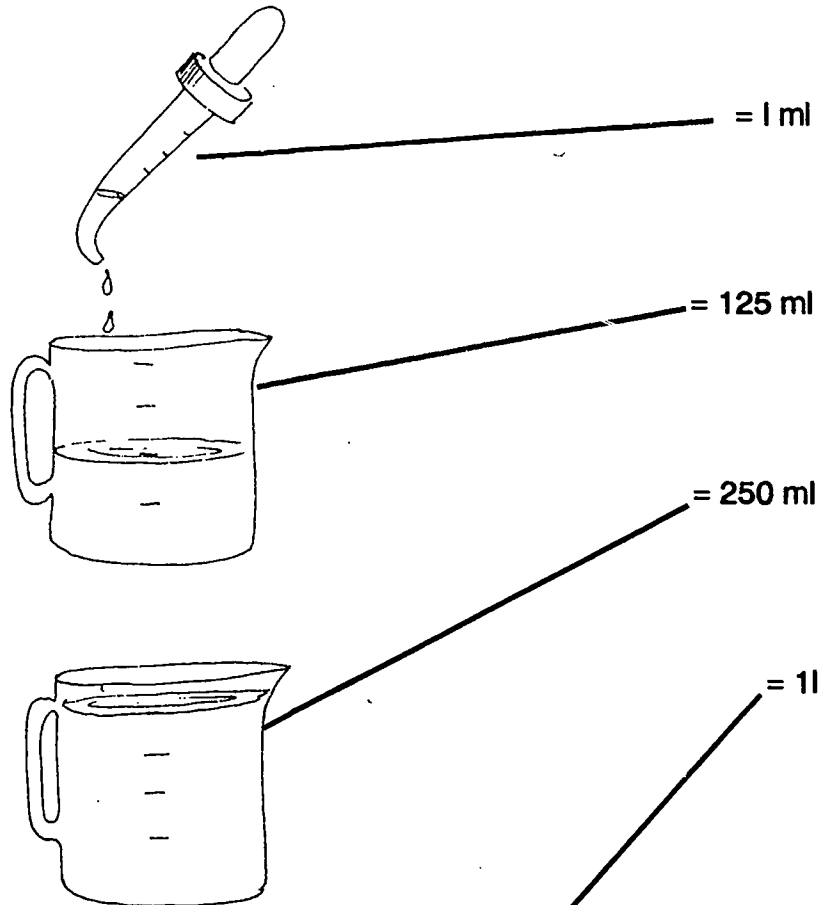



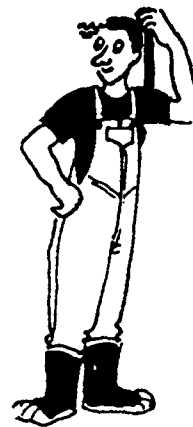

1. How many millilitres in 2 cups?

.....

2. How many litres in 12 cups?

.....

3. Name some items usually measured in millilitres.

.....

4. Name some items usually measured in litres.

.....

5. Convert to litres:

(a) 5000ml ..... (b) 24260ml ..... (c) 35ml .....

6. Convert to millilitres:

(a) 1.50l ..... (b) 65l ..... (c) 0.84l .....

7. A chemical label might say: "Clean equipment by flushing with water and detergent, flush with plain water, then wash with washing soda (1 part to 500 parts water)"

How would you measure this mixture?

.....

.....

**Practise your maths and measuring skills, and you will soon get the hang of litres and millilitres.**

Look at the table below. It comes from the Roundup label booklet.

PERENNIAL WEEDS				
RATE*		Boom L/ha	Handgun vol/100L	Knapsack vol/15L
WEEDS CONTROLLED	STATE			
Bent grass <i>Agrostis tenuis</i>	VIC TAS only	2.5L	500ml	75ml
Blady grass <i>Imperata cylindrica</i>	QLD NSW only	9L	1.3L	200ml
Bracken <i>Pteridium esculentum</i>	All States	9L plus PULSE 200ml per 100L spray	1.5L	225ml
Carpet grass <i>Axonopus spp</i>	All States	3L	500ml	75ml
Cocksfoot <i>Dactylis glomerata</i>	All States	3L	700ml	100ml
Couch <i>Cynodon dactylon</i>	All States	9L	1.3L	200ml



The table tells you how much Roundup to use for different weeds.

For example, if you are using **knapsack** equipment to spray Bent grass, you will need to add **75 millilitres** of Roundup to every **15 litres** of water in your knapsack.

If you are using **Boom** equipment to spray carpet grass you will need **3 litres** of Roundup for every **hectare** you are going to spray.

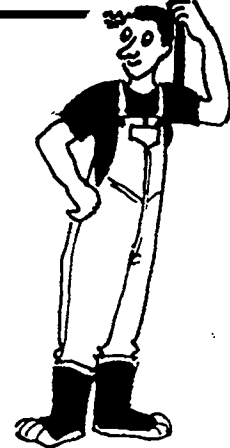

Using the information given in the table, solve the following problems.

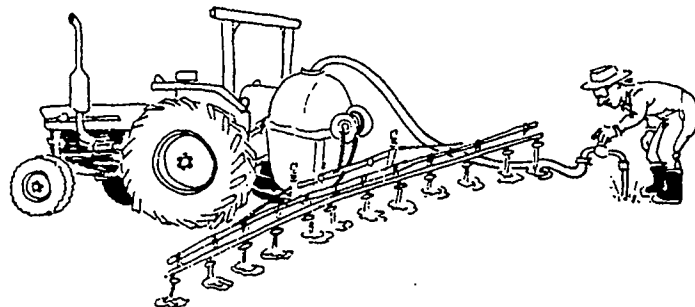

1. Using your Boom equipment you want to treat 6 hectares of pasture. The area is infested with Bent grass. Using the recommended rate, how many litres of Roundup will you require.

.....



2. You want to spray a hillside covered in Couch. Your knapsack holds 10 litres. Using the recommended rate and a full knapsack, how many millilitres of Roundup will you require.

.....



3. You want to treat an area infested with Bracken. You will use Handgun equipment and a spray tank containing 50 litres of water. Using the recommended rate, how many millilitres of Roundup will you require.

.....



100.

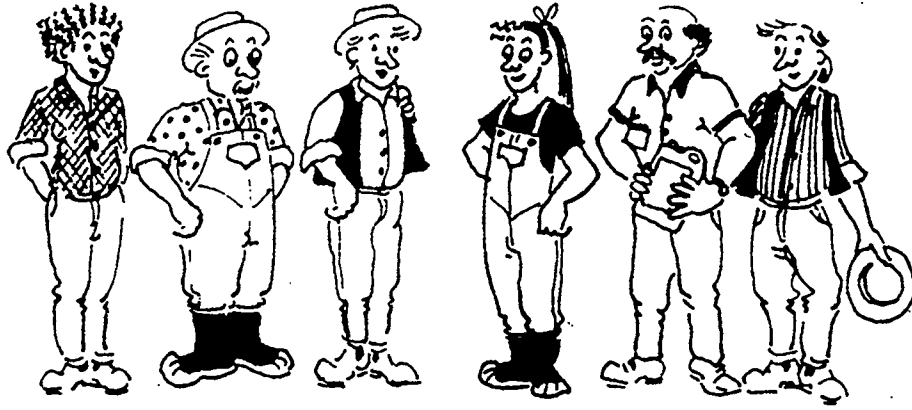

**(v) Glossary:**  
**Measuring with Metrics**

## **Glossary: Measuring with Metrics**

<b>millimetre</b>	is 1/10 of a centimetre. It has the symbol mm.
<b>centimetre</b>	is 10 millimetres. It has the symbol cm.
<b>metre</b>	is the basic unit of length. It is 1,000mm or 100cm. It has the symbol m.
<b>kilometre</b>	is 1,000 metres. It has the symbol km.
<b>square millimetre</b>	1mm x 1mm. It has the symbol mm <sup>2</sup> .
<b>square metre</b>	1m x 1m or 1,000mm x 1,000mm. It has the symbol m <sup>2</sup> .
<b>square centimetre</b>	1cm x 1cm or 10mm x 10mm. It has the symbol cm <sup>2</sup> .
<b>hectare</b>	100m x 100m. It has the symbol ha. It is 10,000 square metres.
<b>AREA</b>	is length x breadth. It's basic unit is the square metre.
<b>PERIMETER</b>	is the total length around the outside of a shape.
<b>VOLUME</b>	is the length x breadth x depth.
<b>cubic centimetre</b>	is 1/1,000 of a cubic metre. It has the symbol cm <sup>3</sup> .
<b>cubic metre</b>	is 1m x 1m x 1m equal to 1,000 cubic decimetres or 1,000 litres of volume. It has the symbol m <sup>3</sup> . There are 1,000m <sup>3</sup> in a litre.
<b>millilitre</b>	is the smallest unit of capacity. It has the symbol ml. There are 1,000ml in a litre.
<b>litre</b>	is 1,000 millilitres or 1 cubic decimetre. It has the symbol l. It is a measure of capacity.

<b>milli</b>	is one thousandth. It has the symbol m.
<b>centi</b>	is one hundredth. It has the symbol c.
<b>deca</b>	is ten times. It has the symbol da.
<b>deci</b>	is one tenth. It has the symbol d.
<b>hecto</b>	is one hundred times. It has the symbol h.
<b>kilo</b>	is one thousand times. It has the symbol k.
<b>mega</b>	is one million times. It has the symbol M.

These symbols are often combined with other symbols to make metric terms.  
For example -

ml = millilitre

mm = millimetre

kg = kilogram

km = kilometre